

OWNER / OPERATOR MANUAL

Keep this manual with the boat at all times.
All operators must read and fully understand the
operational instructions before the boat is used.



- Z-Comanche®
- Z-500 / Z-100
- Reata®
- Fisherman
- Angler
- Bay Ranger®
- Intracoastal
- Ranger Trail® Trailers

Ranger® BOATS

rangerboats.com

Ranger® boats include a wide variety of advantages in quality, construction and performance. For even more details, visit us at www.rangerboats.com



RPM Performance™
Control Post®
Dri-Latch®
COOL Hub®

GETTING TO KNOW AND HANDLE YOUR RANGER BOAT . . .

Your Ranger dealer should see that you have selected the proper horsepower engine for the rating range of the boat model you have chosen. The proper engine mounting height has been selected for optimum performance and the correct propeller has been chosen.

Since most boats spend more time on the trailer than in the water, a RangerTrail® trailer can extend the useful life of your new boat. The load **MUST** be evenly distributed on the properly fitting “bunks” or “pads” of the trailer. The boat should not rest on the loading rollers, but should properly cradle on the bunks.

Always park your rig so that the trailer tongue is higher than the stern of the boat, so that any water can drain from the hull when the drain plug is removed. All livewell valves should be placed in the “empty” position to properly drain your livewell plumbing.

A properly fitted boat cover will protect your investment from the damaging effects of the ultraviolet rays of sunlight, as well as from road film, rain and dirt abrasion while trailering. The cover also protects your accessory equipment and fishing tackle from “prying eyes” and helps to guard against pilferage.

Familiarize yourself with the instruments and indicators used with all installed equipment. Factory equipment manuals are included to assist you to properly operate your trolling motor; depth finders; engine tachometer; speedometer; and any additional accessories that you have installed. Naturally this Ranger manual is only complete when you have completely studied your engine operating manual and are familiar with engine operation.

Now you are ready for a ride in your new boat! This will be an exciting, fun experience if you exercise the proper caution and observe all safety rules and regulations.

Before launching your boat... stop on the ramp short of the water. Stop your vehicle’s engine and set the parking brake. At the rear of the boat, install your transom drain plug and remove the trailering tie-downs, trailering arms, motor supports and/or support brackets. Slowly back the boat and trailer into the water and unhook the winch strap hook. When in the driver’s seat, put on and secure your life vest and attach the engine emergency stop switch lanyard to your person. Start engine and back your boat off the trailer. You should experience no problem if the water is adequately deep for proper launching.



NOTICE

Failure to store/park your rig with the bow elevated could allow rain water to accumulate in the storage boxes.

While you are easing along within the “No Wake” zone you should trim your engine all the way down to its lowest position (in). Turn the steering right and left to insure that there is no undue slack and inspect the steering system. Look for any loose connections at the engine and beneath the driver’s console (see pp. 23-26). Inspection of this crucial linkage system can be visually made at home or at the lake, but should be done at regular intervals. Before applying power and “opening it up”, insure that all passengers are properly seated and are wearing an approved Personal Flotation Device (PFD or Life vest). Check to see that there are no obstructions in your path. We recommend that the front pedestal seat be removed from the front deck base and positioned in the special base provided in the front floor of the boat. If your boat has non-adjustable pedestals, remove the extension pipe from the seat base and install the seat base directly into the front deck receptacle. If your boat has an optional deck extension and power pedestals, remove the lid in the deck extension and secure the pedestal in the receptacle provided in the floor. If the optional deck extension does not have a removable lid, store your seat securely in the floor of the boat. This will provide for an unobstructed view while driving. The power pedestal should be pushed down into the lowest position. Should there be no base provided in the floor, the seat should be removed and securely placed in the floor of the boat.

When you have cleared the “No Wake” zone it is time to accelerate and get your new boat “on plane”. Before applying power, insure that all passengers are properly and securely seated in appropriate locations. Abruptly move the throttle lever into the full open position (full forward). The bow of the boat will rise into the air for a moment... this is normal operation when a boat is “coming out of the hole” and is no cause for alarm. The bow will quickly come back down into a level running position. When the boat begins to accelerate rapidly, the throttle should be pulled back to obtain a comfortable running speed. Always increase your speed a little at a time until you are running at a speed at which you feel safe and are in complete control...**NEVER FASTER THAN YOUR EXPERIENCE**

DICTATES! At this moderate speed you should begin to trim your engine into a higher position (out). Please refer to your engine owner's manual for more information on power trim use and operations.

Your speed will increase and the bow will lift. The boat will begin to run with the back rear portion of the hull in contact with the water and steering will become easier. Over-trimming will result in excessively high RPM (note your tachometer) and the steering can develop "torque" or a "pull" toward the right. Trim back down slightly for best operation. A different trim setting (see your trim indicator) will be required for different throttle settings. You will soon develop an instinctive feel for these settings. Your ear will become attuned to the sound of the proper engine RPM. Again, over trimming is to be avoided as excessive RPM can cause engine damage and can also cause your prop



WARNING

Improper use of power trim may lead to excessive bow steer or steering torque (pull) and could lead to accidental injury or death.

to "blow out" (lose its grip on the water because it is too near the surface). If the bow of your boat should begin to bob up and down (called porpoising) you will probably have over trimmed. Bump the trim button down a little until the motion stops.

If your boat should continue to "porpoise", a slight increase in throttle and speed will generally correct the condition. Proper distribution of the load in your boat will make a great difference in its operation. Moving tackle boxes or ice chests rearward or toward the front can greatly effect boat performance and handling.

When beginning a turn with the engine trimmed in the higher positions, the trim switch should be pressed to LOWER the engine further into the water just prior to and during the turning of the steering wheel. Practice and experience will determine just how far down you will need to trim for safely handling a turn at various speeds and water conditions. Just remember to MAKE SAFETY YOUR GUIDE when attempting any new or unfamiliar maneuver. PROCEED ONLY AT SPEEDS AT WHICH YOU FEEL SAFE AND IN CONTROL!

Naturally, it is impossible to describe here all the different situations that you may encounter. Just remember that COMMON SENSE is your best safety precaution. Your new boat is built to safely carry you in NORMAL OPERATION, but it is up to you to stay alert and to avoid dangerous situations. Safe boating is in the hands of the operator.

Even the pleasant experience of the "first ride in your new boat" must sometime come to an end. Hopefully you have purchased a "drive on" trailer with your boat. The key to simple and effortless loading of your boat is having the trailer in the proper position. This "right" position is determined by the steepness of the ramp. Here, you will have to experiment with the proper depth to have your trailer in. The most common mistake is having the trailer too deep, so a little time spent experimenting with different depth positions can ultimately save you much time and embarrassment. To load at slow speed, position your boat to head directly between the guide bunks or guide rollers and use the thrust of your outboard engine to drive the boat forward until the bow contacts the roller on the bow stand block. Shut down your outboard and fasten the winch strap hook to the bow eye. Tighten the winch strap and lock winch before pulling the boat from the water. Your engine should be trimmed up into a higher position before the trailer is pulled up the ramp to prevent damage to the lower unit or propeller. Pull the rig up the ramp and park well out of the way of other boaters. Stop your vehicle engine and set parking brake. Remove the drain plug, open and drain the livewell systems, and stow all loose equipment. We recommend that you install a transom saver, or engine support brace, between the trailer frame and the lower unit of your engine to prevent damage to your transom while the boat is in transit.

For the most possible boating and fishing enjoyment familiarize yourself completely with your boat and with the instruction manuals for all additional equipment. If you are a novice, there are publications on good seamanship recommended to make your boating safe and enjoyable. We also recommend that you enroll and attend any of the excellent safe boating courses offered and conducted by your area Power Squadron or the U.S. Coast Guard Auxiliary.



WARNING

The operator (driver) is responsible for the correct and safe operation of the boat, the equipment aboard and the safety of all occupants aboard. We strongly recommend that the operator read this manual and thoroughly understand the operational instructions for the engine and all related accessories before the boat is used.

BE RESPONSIBLE FOR SAFER BOATING

- **ALCOHOL and DRUGS** - The debilitating effects of alcohol and other drugs reduces reaction time and detracts from judgment. The combined effect of the outdoor environment... sun, heat, rough water, and noise can be more fatiguing than one would imagine and, combined with drugs or alcohol, can be very dangerous.
- **GAME PLAN** - Tell a friend, neighbor, or another family member where you will be boating and when you plan to return. Be certain that this individual has a good description of your boat and any other identifying information that could be needed to help find you should an emergency arise.
- **VISIBILITY** - Be sure the operator's visibility is not obstructed. On models with bases, adjust the seat for best visibility. (Some saltwater bay models may have limited visibility in the seated position).
- **TOOLS and SPARE PARTS** - Many people have been stranded by minor breakdowns that they could have repaired themselves. It is a good idea to carry a few tools and common spare parts and to be familiar with simple repairs that can be easily accomplished.
- **GASOLINE RESERVES** - Never push your boating range to the limit of your gas tank capacity... one-third of the fuel to go, one-third to come back and one-third to reserve.
- **GOOD BOAT KEEPING** - A clean boat is a safer boat. Take care to see that rods, lures, nets, gaffs and other potentially harmful gear are properly stowed so that it cannot blow or move around while the boat is underway. Perform all maintenance and safety checks regularly. Secure all icebox or cooler lids and place any trash or debris safely under cover until the trip is over.
- **BOARDING LADDER** - Many models are equipped with a boarding ladder. Rotating propeller may cause serious injury or death. Do not approach or use the ladder when engine is running. Shut off the engine when near persons in the water. Make sure to stow the ladder after it is used and before starting the engine. Never use a damaged ladder.
- **SPEED and SKILL** - The fast and powerful boat can require the operator to exercise a high level of skill and attention to driving. Only go as fast as your skill and good judgment dictates is safe. You are in charge of the wellbeing of your passengers and yourself. Be alert for any hazards in the water and operate your boat in such a manner as would be appropriate for the water conditions. Be a good boating "neighbor" and do not create a hazard or annoyance to others. The best safety equipment is your own good judgment.
- **SKIERS and SWIMMERS** - Do not allow operation of the engine when anyone is in the water near the stern of the boat. Never back up to a down skier or anyone in the water. Never drive your boat directly behind a skier.

CARBON MONOXIDE

Carbon monoxide is a deadly gas that is odorless, tasteless and colorless. It is present in the exhaust of internal combustion engines. Inhaling sufficient concentrations of carbon monoxide can be fatal within minutes. Early signs of carbon monoxide poisoning may include headache, nausea, fatigue, drowsiness, confusion and vomiting. **DO NOT MISTAKE THESE SYMPTOMS FOR SEASICKNESS.** If any of these symptoms occur to you or any of your passengers, ventilate the boat by opening the side curtains or forward hatch to remove the fumes and immediately seek medical attention.

Carbon monoxide can be drawn into the cockpit area over the stern of the boat. When operating the engine, ventilate the cockpit area by removing side curtains or opening forward hatches to allow fresh air to flow through. Do not operate the engine if your boat is moored in a confined area.



WARNING

Exhaust from a running engine can cause an accumulation of carbon monoxide gas in the cockpit area when the canvas top and side curtains are installed. Provide adequate ventilation when these coverings are installed in their closed positions.

TABLE OF CONTENTS

Getting to Know and Handle Your Ranger Boat	1-2
Be Responsible for Safer Boating	3
Carbon Monoxide Warning	3
Special Information	5
Your Ranger Dealer's Responsibilities	5
Owner/Operator's Responsibilities	5-6
Warnings	6
Hazard Labeling	7-9
Hull Identification Plate	10
U.S. Coast Guard Capacity Information Plate	11
Recommended On-Plane Seating Locations	12
Gasoline Fuel System	13
Your Livewell Aeration System	18
Steering at Console	25
Your Boat's Finish	28
Maintenance and Repair	28-29
Your Power Pedestals	29
Key Locks, Carpet, and Upholstery	31
Cleaning Upholstery	31-32
Adding Accessories To Your Boat	33
Hook Up of Trolling Motor Leads	33-34
Battery Requirements	34
Wiring Diagrams	35-45
Electrical System	46
Fuse Panel Information	46-47
1850, 2050, 1880, 2080	47-48
620FS and 621FS	48-51
Saltwater Series - 220, 240	52
Saltwater Series - 2360, 2350, 2510 Bay	53-54
Z520c, Z521c	55-5
Z518L, Z519L, Z520L, Z521L Models	61-64
Safety and Maintenance Tips	65
Boating Safety Checklist	65
Federal Requirements for Recreational Boats	67

YOUR RANGER TRAIL® TRAILER

General Information and Maintenance	68
Contained Oil Orbital Lubrication (COOL) Hubs	68
Reporting Safety Defects	68
Trailer Brakes	69
RangerTrail Wiring	70
Before Towing Your RangerTrail Trailer	71
Towing Your RangerTrail Trailer	71
Swing Hitch	72
Hitch Class Rating	72
Trailer Tire Safety, Care and Maintenance	73-76
Trailer Exploded View	77
RangerTrail Parts List	77
Limited Warranty	78-79

SPECIAL INFORMATION

The following special information is intended to alert you to possible dangers and to information important to the safe operation of your boat and other equipment. Observe them carefully. However, simply being aware of the "WARNING", "CAUTION" AND "NOTICE" notations in this manual will not eliminate the dangers that they signal if you do not implement the information. These warnings, plus common sense operation will insure you a safe and fun boating or fishing outing.

Please take special note when you see one of the following signs:



WARNING

Failure to follow the advice of a "WARNING" may result in bodily injury or death.



CAUTION

Non-compliance with "CAUTION" instructions could result in failure of, or damage to, the product and/or equipment.



NOTICE

Draws special attention to installation, operation, or other important maintenance information.

ALL information or instructions in this manual could be necessary for proper operation and/or maintenance. If you do not understand any portion of this manual, please contact your Ranger dealer or our Customer Service Department for any additional information.

IMPORTANT: Your Ranger Dealer's Responsibilities...

Generally, it is the dealer's responsibility to the customer to make sure that the boat has been equipped as ordered with a properly installed and functioning engine that is within the horsepower rating specified for that model boat. The dealer should see that the engine is outfitted with the proper propeller for that boat model and for the load that the boat is normally expected to carry.

The dealer should help to familiarize the customer with the onboard equipment and explain operation of this equipment; the engine operation; and the proper functioning and operation of the boat itself.

Prior to delivery, the dealer should make certain that the product and equipment is completely operational; the proper propeller is installed; and that all oil, fuel system and lubrication systems are understood. The dealer should explain the operation of all instrumentation equipment, and the boat electrical and livewell systems.

The dealer should check for correct carburetor adjustment, throttle and steering functioning, and instrumentation accuracy. Engine cooling water should be properly circulating.

The dealer should test for maximum engine RPM as specified in the engine manufacturer's specification sheet(s) and/or engine owner's manual for proper operation of all equipment and for proper adjustment of steering effort and direction. All necessary adjustments for maximum efficiency should be made.

Owner/Operator's Responsibilities...

It is the owner/operator's responsibility to perform all safety checks and to ensure that all lubrication and maintenance instructions are complied with for maximum safety and proper operation.

Special Information

It is also the owner/operator's responsibility to return the unit to the Ranger dealer for a periodic checkup.

The owner/operator is responsible for the correct operation of the boat and for the safety of its occupants. Be sure that all operators read this manual before attempting to operate the boat. Your passengers should be shown the location and use of all emergency equipment and one passenger should be instructed how to handle the boat in case of emergency. U.S. Coast Guard requirements for PFDs (Personal Flotation Devices, or Life vests) can vary, depending on the type of boat. Be sure to comply with the U.S. Coast Guard regulations that apply to your boat. The owner/operator should, however, make certain that all passengers in the boat are in possession of, and are securely wearing a PFD whenever the boat is in operation. We strongly recommend that an engine emergency stop switch be securely connected to the boat operator any time that the engine is in operation!

Learn the waterway rules of the locality in which you intend to operate your boat. Navigable waterways are controlled by Federal regulations while inland lakes and Canadian waters are controlled by local jurisdictions. Obey all regulations to protect yourself, your passengers, and fellow boating enthusiasts.

Before boating, obtain the weather forecast for your area. Familiarize yourself with the weather bureau warning system signal(s) and waterway traffic sign/markings information.

Contact your local U.S. Coast Guard Auxiliary and take advantage of their excellent boating and safety classes and seasonal boat inspections.

WARNING

Operating a boat with an engine of horsepower in excess of that specified on the boat's capacity plate can result in loss of control over the boat's operation and could lead to an accident resulting in injury or death of the boat's occupants.

WARNING

Imprudent operation of the boat, with or without the use of PFDs and an approved engine emergency stop switch, can lead to property damage, injury or death of the boat operator or passenger(s), or other(s), whether within the boat or outside the boat.

WARNING

The boat operator should insure that the lanyard connection to the emergency stop switch is of ample length to insure that the inadvertent activation of the switch is not likely. Accidental triggering of the emergency stop switch could result in loss of engine power at inopportune times, such as while docking or in heavy seas, strong currents or high winds and could lead to an accident resulting in injury or death.

WARNING

Do not exceed the maximum weight and persons capacity found on the U.S. Coast Guard capacity information plate located on your boat. Overloading severely affects the stability and handling of your boat and could lead to an accident causing injury or death.

WARNING

Sudden turns or striking waves or objects can eject person(s). Unmanned boat can circle and can repeatedly strike the person(s) with propeller. Attach the emergency stop lanyard and wear life jacket when operating the boat.

WARNING

Striking floating or submerged objects can cause outboard motor to break loose and flip into boat with propeller still spinning. Do not exceed minimum planing speed in areas likely to contain floating or submerged objects.

HAZARD LABELING

The following images are a partial list of warning/information decals that may be found in various locations on your boat and trailer. (Photos are not to scale) Some labels are not appropriate for every boat/trailer model, so your rig may not have them all. Check with your Ranger dealer to find out what labels your boat and trailer should have and ask them to order any necessary replacements.

WARNING Fuel Tank located in this area. To avoid puncturing tank and causing fuel leakage, do not drill, screw, or modify this area. Leaking fuel is a fire and explosion hazard.

CAUTION
CHECK ENGINE CLEARANCE BEFORE TRIMMING

WARNING
To minimize shock and fire hazards:
• This device must be connected to a Ground Fault Circuit Interrupt (GFCI) protected AC outlet
• When using an extension cord, connect the AC charger plug before connecting to the GFCI protected AC outlet.
• Make connection in an open atmosphere free of explosive fumes.
• Make connection in a secure manner that will avoid contact with water. GM2648701

RECOMMENDED ON-PLANE SEATING LOCATIONS

BEFORE USE, PUSH UP ON TAB TO ASSURE BRAKES ARE RELEASED 32588

WARNING
Install ski pylon securely before use. Insert pin thru receiver and ski tow pylon. Pushing pylon into mounting hole until red line is no longer visible. Install pin thru receiver and pylon to secure position. Failure to secure pylon may result in possible injury or death.

CE RANGER BOATS SAMPLE MAXIMUM 5 + 1 + 1 + 1 = 690 kg D = 97 kw

WARNING
65 PSI
TIRE PRESSURE MUST BE MAINTAINED FOR PROPER LOAD CARRYING AND TO AVOID IRREGULAR WEAR!

WARNING
50 PSI
TIRE PRESSURE MUST BE MAINTAINED FOR PROPER LOAD CARRYING AND TO AVOID IRREGULAR WEAR!



WARNING
AVOID SERIOUS INJURY OR DEATH. DISLODGED SEAT MAY STRIKE OCCUPANT OR CAUSE LOSS OF BOAT CONTROL.
SECURE UNOCCUPIED SEAT.

DANGER
Carbon Monoxide (CO) can cause brain damage or death. Engine and generator exhaust contains odorless and colorless carbon monoxide gas. Carbon monoxide will be around the back of the boat when engines or generators are running. Move to fresh air, if you feel nausea, headache, dizziness, or drowsiness.
Rotating propeller can cause serious injury or death never approach or use ladder when motor is running.

WARNING
Carbon Monoxide (CO) can cause brain damage or death. Engine and generator exhaust contains odorless and colorless carbon monoxide gas. Signs of carbon monoxide poisoning include nausea, headache, dizziness, drowsiness, and lack of consciousness. Get fresh air if anyone shows signs of carbon monoxide poisoning. See Owner's Manual for information regarding carbon monoxide poisoning.
Rotating propeller can cause serious injury or death. Shut off motor when near persons in water.

DANGER
Carbon Monoxide (CO) can cause brain damage or death. Engine and generator exhaust contains odorless and colorless carbon monoxide gas. Carbon monoxide will be around the back of the boat when engines or generators are running. Move to fresh air, if you feel nausea, headache, dizziness, or drowsiness.
Rotating propeller can cause serious injury or death never approach or use ladder when motor is running.
Leaking Fuel can cause serious injury or death from fire or explosion. Inspect system for leaks at least once a year. Fuel contents can be under pressure. Open cap slowly in well ventilated area. No smoking or open flames. The use of fuels containing ethanol higher than 10% (E-10) can damage your engine or fuel system and will void the warranty. Never use (E-85).

WARNING
Fuel contents can be under pressure. Avoid serious injury or death from fire or explosion. Open slowly in well ventilated area. No smoking or open flames.

WARNING
SUDDEN TURNS ABOVE 65 MPH MAY CAUSE LOSS OF BOAT CONTROL, WHICH COULD RESULT IN SERIOUS INJURY OR DEATH. REDUCE SPEED BEFORE ATTEMPTING A SUDDEN SHARP TURN. READ OWNER'S MANUAL FOR ADDITIONAL INFORMATION.

Check lug nuts for proper tightness and read owner's manual before use.

WARNING
BEFORE TOWING, ALWAYS INSTALL A PIN OR LOCK INTO COUPLER TO ENSURE THAT LATCH CANNOT OPEN AND COUPLER CANNOT COME OFF BALL.

FOR MAXIMUM PERFORMANCE TROLLING,
MOTOR BATTERIES SHOULD NOT EXCEED 110
POUNDS.

 **WARNING**

Engine mounting location preset at the factory.
Adjustments can result in damage to control system equipment.
Control system damage can result in serious injury or death.
Regularly inspect control system and clearances at all trim angles.

 **CAUTION**

CHECK TIGHTNESS OF OUTBOARD AND
JACKPLATE MOUNTING BOLTS AFTER 1ST 10
HOURS AND AT EVERY 30 HOURS OF USE.
TIGHTEN MOUNTING FASTENERS TO ENGINE
MANUFACTURER'S SPECIFICATIONS.

 **WARNING**



Do not use ski tow fitting for
lifting or parasailing.
Fitting could pull out of deck
resulting in serious injury
or death.

GM1850801

 **WARNING**

AVOID PERSONAL INJURY

MISUSE OF TOWER CAN OVER STRESS TOWER OR DANGEROUSLY IMBALANCE BOAT.
FAILURE TO FOLLOW THESE GUIDELINES CAN RESULT IN INJURY OR DEATH.
THIS TOW TOWER TO BE USED FOR TOWING WAKEBOARD AND SKI DEVICES ONLY.
DO NOT TOW MORE THAN TWO PERSONS AT A TIME FROM THIS TOWER.
DO NOT USE TOWER FOR LIFTING, PARASAILING OR TOWING OTHER WATERCRAFT.
DO NOT ALLOW PASSENGERS TO SIT BEHIND ROPE ATTACHMENT POINT
WHEN TOWER IS IN USE. DO NOT ALLOW LOOSE TOW ROPE ENDS TO DANGLE.
DO NOT CLIMB ON, HANG ON, SIT ON, JUMP OR DIVE OFF THIS TOWER.
CHECK ALL TOWER FASTENERS FOR TIGHTNESS BEFORE USING TOWER.

 **WARNING**

SUDDEN TURNS ABOVE 30 MPH
MAY CAUSE LOSS OF BOAT CONTROL.
AVOID SERIOUS INJURY OR DEATH.
REDUCE SPEED BEFORE ATTEMPTING
A SUDDEN SHARP TURN.
READ OWNER'S MANUAL.

THIS BOAT HAS BEEN DESIGNED FOR A
MAXIMUM OUTBOARD ENGINE
WEIGHT OF 735 LBS.

 **WARNING**

SUDDEN TURNS ABOVE 60 MPH MAY
CAUSE LOSS OF BOAT CONTROL, WHICH COULD
RESULT IN SERIOUS INJURY OR DEATH.
REDUCE SPEED BEFORE ATTEMPTING
A SUDDEN SHARP TURN.
READ OWNER'S MANUAL FOR
ADDITIONAL INFORMATION.

 **WARNING**



Visibility from the seated position at
this helm is limited. Avoid serious
injury or death from collisions
Operation from a standing position
may be necessary to maintain a
lookout as required by Rules of the
road. Read owners manual.

GM1906501

 **WARNING**



Fuel vapors are a fire and
explosion hazard. To avoid
injury or death, do not store
fuel or flammable liquids here.

GM1850701

 **WARNING**



Avoid serious injury or death
from fire or explosion,
resulting from leaking fuel.
Inspect system for leaks
at least once a year.

GM1850601

UP → **DOWN**
Tow Position **Brake Applied**

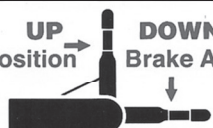

**PARKING BRAKE
EQUIPPED**
Release brake before towing

 **CAUTION**

Parking brake is intended as a means of added security
and should not be relied upon as the sole method of
securing trailer. Continue to use wheel chocks or other
traditional methods to ensure the trailer remains in
desired parked position.

AUSTRALIAN BUILDERS PLATE

MANUFACTURER: RANGER BOATS
 MODEL: MODEL NAME
 BUILD DATE: MODEL YEAR
 INFORMATION DETERMINED BY: ABYC STANDARDS

MAX OUTBOARD = 200 HP
 256 kg

MAX PERSONS: 5 = 306 kg

MAX LOAD: = 612 kg

BUOYANCY: LEVEL FLOTATION

WARNING

ALTERATION OF THE BOAT'S HULL OR PERMANENT FITTINGS
 MAY INVALIDATE THE PARTICULARS ON THIS PLATE

WARNING

MAX. TRAILER
 GVWR 7,500 POUNDS
 TONGUE LOAD RATING
 MIN. 5% GVWR
 MAX. 750 POUNDS
 FOR TRAILER CAPACITY
 SEE "VIN" LABEL
 TO SECURE LATCH
 ALWAYS INSTALL A PIN
 OR LOCK INTO COUPLER
 SIDE HOLE
 USE ONLY SAE 2" BALL
 WITH PROPER RATING
 USE SAFETY CHAINS
 CHECK FLUID LEVEL
 READ OWNERS MANUAL
 BEFORE USE
 SAE AND V5 CLASS 4
 MODEL A-60 / A-75

UFP
 SAN MARCOS, CA.
 PATENTED
 MADE IN USA

32206

WARNING
 AVOID SERIOUS INJURY OR DEATH

SEAT LOCATION NOT INTENDED FOR USE AT HIGHER SPEEDS
 DO NOT OCCUPY SEAT WHEN SPEED EXCEEDS 5 MPH.
 DISLODGED SEAT MAY STRIKE OCCUPANT OR CAUSE LOSS OF BOAT CONTROL.
 SECURE UNOCCUPIED SEAT

Class **B**

SPRINGFIELD
 The Springfield Marine Company

Class **B**

LABEL # 8123050

WARNING
 AVOID SERIOUS INJURY OR DEATH

UNEXPECTED SEAT ROTATION MAY CAUSE EJECTION OF OCCUPANT
 LOCK SWIVEL WHEN SPEEDS EXCEED 5 MPH
 DISLODGED SEAT MAY STRIKE OCCUPANT OR CAUSE LOSS OF BOAT CONTROL
 SECURE UNOCCUPIED SEAT

Class **AD**

SPRINGFIELD
 The Springfield Marine Company

Class **AD**

LABEL # 8123052

WARNING

A wide variety of components used on this vessel contain or emit chemicals known to the State of California to cause cancer and birth defects and other reproductive harm.

EXAMPLES INCLUDE:

- Engine and generator exhaust
- Engine and generator fuel, and other liquids such as coolants and oil, especially used motor oil.
- Cooking fuels.
- Cleaners, paints, and substances used for vessel repair.
- Waste materials that result from wear of vessel components.
- Lead from battery terminals and from other sources such as ballast or fishing sinkers.

TO AVOID HARM:

- Keep away from engine, generator, and cooking fuel exhaust fumes.
- Wash areas thoroughly with soap and water after handling the substances above.

California Health & Safety Code §§ 25249.5-13

NW501-11

CANADIAN COMPLIANCE NOTICE
AVIS DE CONFORMITÉ CANADIEN

RANGER BOATS (RGR)
 FLIPPIN, AR, USA
 MODEL / MODÈLE: 621 VS



THE MANUFACTURER DECLARES THAT THIS PRODUCT COMPLIES WITH THE PLEASURE CRAFT CONSTRUCTION REQUIREMENTS OF THE SMALL VESSEL REGULATIONS AS THEY READ ON THE DAY ON WHICH THE CONSTRUCTION OF THE VESSEL WAS STARTED OR ON THE DAY ON WHICH THE VESSEL WAS IMPORTED.

LE FABRICANT ATTESTE QUE CE BÂTIMENT EST CONFORME AUX EXIGENCES DE CONSTRUCTION DES EMBARCATIONS DE PLAISANCE DU RÈGLEMENT SUR LES PETITS BÂTIMENTS, EN VIGUEUR À LA DATE DU DÉBUT DE SA CONSTRUCTION OU À LA DATE DE SON IMPORTATION

CANADIAN COMPLIANCE NOTICE
AVIS DE CONFORMITÉ CANADIEN

MAXIMUM RECOMMENDED SAFE LIMITS
LIMITES MAXIMALES DE SÉCURITÉ RECOMMANDÉES

 **6** **450 kg**
992 lbs/lb

 +  +  **862 kg**
1900 lbs/lb

 **112 kW**
150 HP **292 kg**
644 lbs/lb

THE MAXIMUM RECOMMENDED SAFE LIMITS MIGHT HAVE TO BE REDUCED IN ADVERSE SEA AND WEATHER CONDITIONS.
 LES LIMITES MAXIMALES DE SÉCURITÉ RECOMMANDÉES PEUVENT DEVOIR ÊTRE RÉDUITES DANS LES CONDITIONS DE MER ET DES CONDITIONS MÉTÉOROLOGIQUES DIFFICILES.

RANGER BOATS (RGR)
 FLIPPIN, AR, USA
 MODEL / MODÈLE:

THE MANUFACTURER DECLARES THAT THIS PRODUCT COMPLIES WITH THE CONSTRUCTION REQUIREMENTS OF THE SMALL VESSEL REGULATIONS AS THEY READ ON THE DAY ON WHICH THE CONSTRUCTION OF THE VESSEL WAS STARTED OR ON THE DAY ON WHICH THE VESSEL WAS IMPORTED.
 LE FABRICANT ATTESTE QUE CE PRODUIT EST CONFORME AUX EXIGENCES DE CONSTRUCTION DU RÈGLEMENT SUR LES PETITS BÂTIMENTS EN VIGUEUR À LA DATE DU DÉBUT DE SA CONSTRUCTION OU DE SON IMPORTATION.

TIRE AND LOADING INFORMATION
RENSEIGNEMENTS SUR LES PNEUS ET LE CHARGEMENT

The weight of cargo should never exceed 1728 kg or 3810 lbs.
 Le poids du chargement ne doit jamais dépasser kg ou lb.

TIRE PNEU	SIZE DIMENSIONS	COLD TIRE PRESSURE PRESSION DES PNEUS A FROID	SEE OWNER'S MANUAL FOR ADDITIONAL INFORMATION
FRONT AVANT	ST215/75R14C	50 PSI	VOIR LE MANUEL DE L'USAGER POUR PLUS DE RENSEIGNEMENTS
REAR ARRIERE	ST215/75R14C	50 PSI	
SPARE DE SECOURS	ST215/75R14C	50 PSI	

Hazard Labeling & Hull Identification Plate

U.S. COAST GUARD
MAXIMUM CAPACITIES

5 PERSONS OR 725 LBS.
1500 LBS. PERSONS, MOTOR, GEAR
225 H.P. MOTOR

THIS BOAT COMPLIES WITH U.S. COAST GUARD SAFETY STANDARDS IN EFFECT ON THE DATE OF CERTIFICATION

MEETS U.S. EPA EVAP STANDARDS USING CERTIFIED COMPONENTS

MANUFACTURER: RANGER BOATS
MODEL: FLIPPIN, AR 72634

DESIGN COMPLIANCE WITH NMMA REQUIREMENTS IS VERIFIED.
MANUFACTURER RESPONSIBLE FOR PRODUCTION CONTROL.

NMMA CERTIFIED NATIONAL MARINE MANUFACTURERS ASSOCIATION

MAXIMUM CAPACITIES

10 PERSONS OR 1650 LBS.
2800 LBS. PERSONS, MOTOR, GEAR
350 H.P. MOTOR

THIS BOAT COMPLIES WITH U.S. COAST GUARD SAFETY STANDARDS IN EFFECT ON THE DATE OF CERTIFICATION

MEETS U.S. EPA EVAP STANDARDS USING CERTIFIED COMPONENTS

MANUFACTURER: RANGER BOATS
MODEL: 2510SE BAY FLIPPIN, AR 72634

DESIGN COMPLIANCE WITH NMMA REQUIREMENTS IS VERIFIED.
MANUFACTURER RESPONSIBLE FOR PRODUCTION CONTROL.

NMMA CERTIFIED NATIONAL MARINE MANUFACTURERS ASSOCIATION

THIS BOAT HAS BEEN DESIGNED FOR A MAXIMUM OUTBOARD ENGINE WEIGHT OF 735 LBS.

MANUFACTURED BY / FABRIQUE PAR: FISHING HOLDINGS, LLC DATE JUL-12

GVWR / PNBV 2268 KG (5000 LB)
GAWR (EACH AXLE) / PNBRE (CHAQUE ESSIEU) 1134 KG (2500 LB) TIRES / PNEU ST215/75R14C
RIMS / JANTE 14x6 LOAD CAPACITY 1728 KG (3810 LB)
COLD INFL. PRESS. / PRESS. DE GONFL. A FROID 345 KPA (50 PSI / LPC) SINGLE DUAL

THIS VEHICLE CONFORMS TO ALL APPLICABLE U.S. FEDERAL MOTOR VEHICLE SAFETY STANDARDS IN EFFECT ON THE DATE OF MANUFACTURE SHOWN ABOVE.
THIS VEHICLE CONFORMS TO ALL APPLICABLE STANDARDS PRESCRIBED UNDER THE CANADIAN MOTOR VEHICLE SAFETY REGULATIONS IN EFFECT ON THE DATE OF MANUFACTURE. - CE VEHICULE EST CONFORME A TOUTES LES NORMES QUI LUI SONT APPLICABLES EN VERTU DU REGLEMENT SUR LA SECURITE DES VEHICULES AUTOMOBILES DU CANADA EN VIGUEUR A LA DATE DE SA FABRICATION.

V.I.N. / N.I.V.: 567RSBN2XCFXXXXXX TYPE / TYPE: TRAILER TRA / REM BOAT CF5000 Z521

HULL IDENTIFICATION PLATE



Year Mfg. Year Model

The hull I.D. Plate is located on the outboard side of the starboard transom, above the water line, and contains the following information:

- Hull Identification Number (Serial Number) - Should also be included in any inquiries or when ordering parts. The U.S.C.G. requires the H.I.N. number be permanently affixed and remain on the starboard transom of the boat. Do not alter this plate in any way.

DESIGNATED OCCUPANT POSITIONS

The following pages show the designated occupant positions for each model with X for the recommended on-plane seating and X for additional occupant locations (up to planing speed only).

A decal similar to the one in figure 1 (below) can be found on your boat in the area of the capacity label (figure 2). The areas marked by X's are the areas of the boat considered safe and suitable for on-plane seating.

The operator of the boat should familiarize themselves with the seating locations that fit into this category. Be sure to read any warnings that may be affixed to the seat, base, or pedestal and follow those instructions.

Type A: A seat designed for occupancy while the vessel is underway at any speed.

Type B: A seat designed for occupancy only at boat speeds not exceeding five miles per hour.

Do not sit in type B seats when boat speed exceeds five MPH.

Do not exceed the loading limits of the capacity plate on your boat (Example figure 2).

FIGURE 1

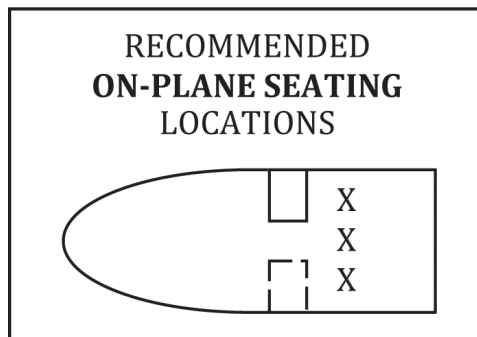

FIGURE 2



WARNING

Do not operate the boat on plane with persons located outside the on-plane locations shown on decal. Failure to do so could cause a person(s) to be thrown overboard resulting in injury or death.

DESIGNATED OCCUPANT POSITIONS

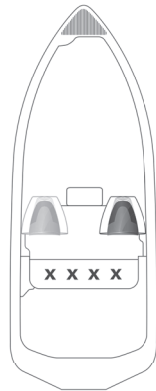

Z518-Z518-Z518L

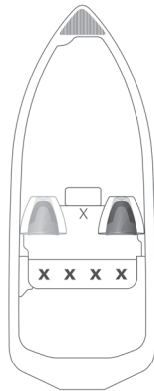

Z521c-Z520c-Z519L
Z519-Z520L-Z521L

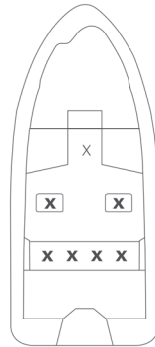

190LS

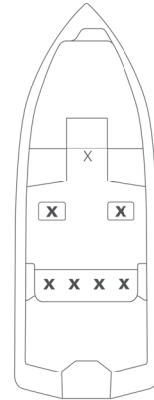

212LS

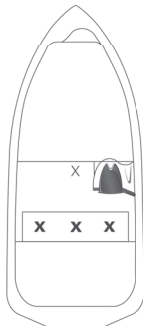

Z175

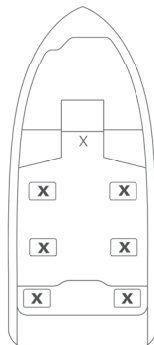

1850MS-1880MS
2050MS-2080MS

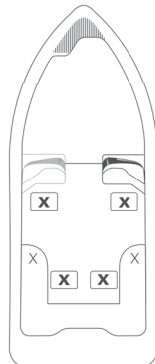

FS619

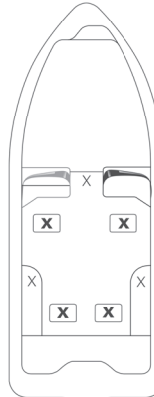

FS620-FS621

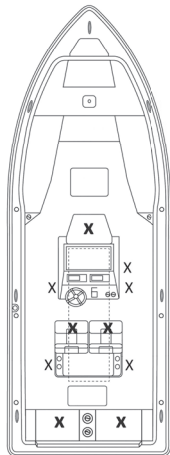

2360 Bay

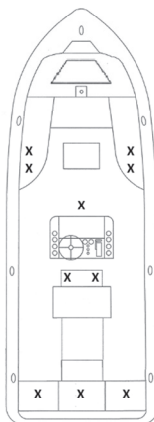

2350 Bay

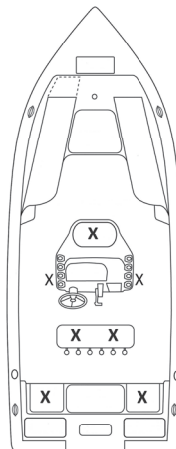

2260 Bay

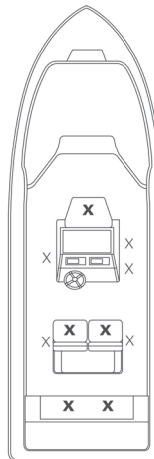

2510 Bay



RECOMMENDED ON-PLANE SEATING



ADDITIONAL OCCUPANT SEATING/STANDING LOCATIONS (UP TO PLANING SPEED ONLY)

DO NOT OCCUPY CASTING DECK(S) WHILE BOAT IS UNDERWAY.

GASOLINE FUEL SYSTEMS

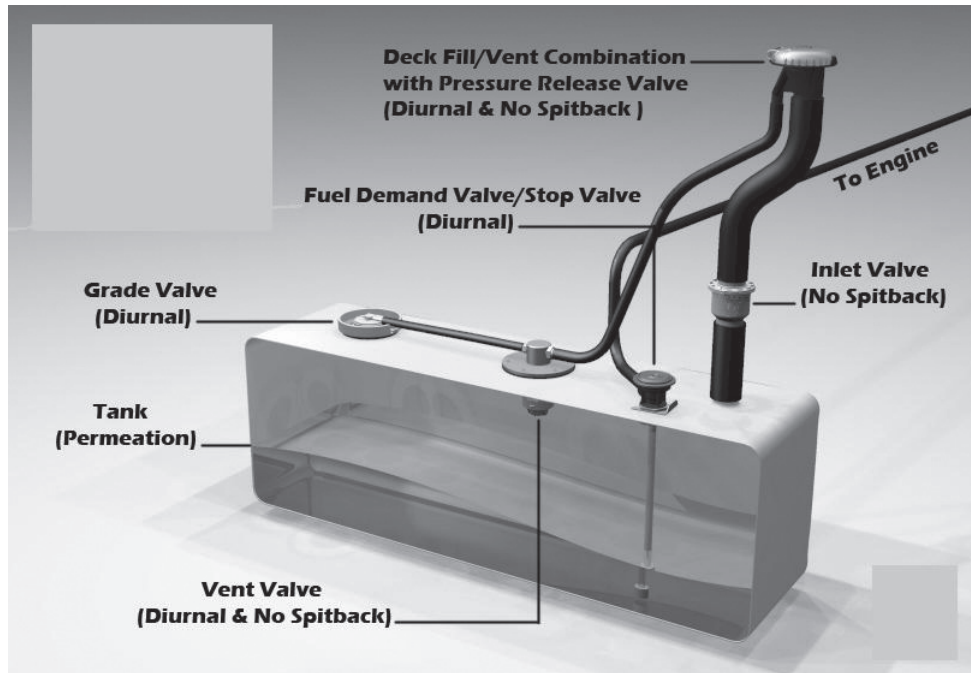

Gasoline fuel systems used in Ranger boats are designed to meet or exceed the requirements of the U.S. Coast Guard, the National Marine Manufacturers Association, the EPA, and the American Boat and Yacht Council at the time of manufacture.

All gasoline fuel systems have been factory inspected and pressure tested in accordance with regulations in effect at time of manufacture. Additionally, each fuel tank must pass rigid tests and inspections performed by the fuel tank manufacturer.

A. FUEL FILLS

Fuel fill deck plates are located on the port side deck, and are marked with the fuel pump symbol.



WARNING

DO NOT confuse GAS deck fill plate with WATER or OIL deck fill plates. Deck fill plates are labeled according to the intended use.

Most models are designed with the pressure relief system shown above. Under certain conditions the system will be under pressure.

Always open the cap slowly to allow pressure to escape. The vented deck fill is designed to maintain system pressure below 1 psi.

While filling the tank, the air displaced by the fuel escapes through the fill/vent. See Figure 1 on the next page.

Periodically inspect the deck fill plate for damage. Be sure to use the exact fuel fill/vent used on your boat if replacement is required. Excessive pressure or vacuum in the fuel tank may damage the fuel system, if cap is substituted. (Fuel fill deck plate is not waterproof; water can be drawn into fuel tank during vent operation, if fill is submerged.)

After fueling, replace the fill cap, and wash the areas around the fuel fill plate, if any fuel is spilled. Residual fuel

left on the deck and hull sides can be dangerous, and will yellow the fiberglass.

FIGURE 1: FUEL FILL



B. FUEL GAUGE

The fuel gauge indicates the amount of fuel in the tank. The fuel level is displayed on the console mounted gauge when the ignition switch is “on”. On models with two tanks, a console mounted switch marked with a fuel pump symbol or just “fuel”, is used to switch the gauge from one tank to the other. Push the fuel pump symbol switch to display the level in tank 1 (starboard) or tank 2 (port). Or, on some models, push the switch to the left to display the port tank fuel level and push to the right to display the starboard tank fuel level. The center position is “off”.

C. FUEL SENDER(S)

Due to the mechanical nature of the fuel sender, variations in readings during various speeds of operation may occur. This system is merely a relative indication of the available fuel supply and not a calibrated instrument. With this type of sending unit a more accurate measurement of fuel level is obtained with the boat in a level position.

D. FUEL VALVE(S)

A fuel hose connects the fuel tank to the engine. On models with more than one tank, a switch valve is installed to switch from tank to tank. This valve, located at the driver seat, on the panel to the right of the driver, is clearly marked and easily operated.

E. FUEL FILTER

Fuel filters are installed on each engine. (Yamaha has an additional fuel filter/water separator in the stern of the boat.) Filters should be changed frequently to assure an adequate supply of fuel to the engine. Refer to the engine manual for additional information. The engine manual is included in the owner’s information packet. Fuel filters mounted in the vicinity of batteries, have a dielectric shield to protect against accidental short-circuiting. When servicing, remove any batteries in vicinity of filter, if shield is removed.



NOTICE

Canister-type filters should be changed annually.

F. FUEL STANDARDS

Be cautious when using gasoline that contains alcohol. Refer to the section on gasoline requirements in your engine manual for additional information. The use of alcohol additives in gasoline has become more widespread. Regulations on public notification of the existence of additives are currently controlled by the Environmental

Protection Agency (EPA). Some states do require that gasoline pumps display information on additives (especially alcohol). If alcohol content is not posted, ask and avoid using fuel containing alcohol if possible.

Although alcohol boosts the octane level in gasoline, it also attacks the rubber fuel distribution lines and even metal fuel system components. Alcohol will permeate most fuel hoses and other components such as fuel pump, gaskets and seals, and can also contribute to fuel system contamination.

The hoses we use in our boats are alcohol-resistant as are the materials used by the engine manufacturers. If only fuel containing alcohol is available, you must perform more frequent inspections for leaks and abnormalities. Any sign of leakage or deterioration requires your immediate attention. Refer to the engine manufacturer's recommendations on fuel type and octane ratings.

G. SAFETY AND MAINTENANCE TIPS

The fuel system in your Ranger requires little or no maintenance. However, the periodic inspection outlined below is strongly recommended. Contact your Ranger dealer for proper fuel tank access for your model.

1. Check your fuel tank(s) for leakage, especially around the sending unit and fuel hose connections.
2. Inspect fuel hoses. A deteriorated hose containing alcohol blended fuels will normally be soft and swollen. A deteriorated hose containing no fuel will be hard and brittle. In both cases the hose(s) should be replaced.
3. Inspect the fuel system fittings at the deck fuel fill, fuel tank vent, tank(s), and (if equipped with more than one tank), the fuel switch valve for signs of leaks or corrosion. Visually inspect for deteriorating metal fittings at the fuel hose connections.
4. Check fuel tank hold down brackets, making sure they are secure.



WARNING

Avoid serious injury or death from fire or explosion, resulting from leaking fuel. Inspect system for leaks at least once a year.

Storage compartments are not designed to store flammable materials, as ventilation may not have been provided.



WARNING

Fuel vapors are a fire and explosion hazard. To avoid injury or death, do not store fuel or flammable liquids in boat. Ventilation has not been provided.

If areas are found within the fuel system that appear questionable, have your Ranger dealer inspect the system. A thorough fuel system examination should be made by an experienced marine technician at least once a year.



CAUTION

Maintenance or repairs should be performed by your Ranger dealer or other qualified personnel.

Naturally a leak-free fuel system is a MUST for proper operation and on-board safety. Always inspect for fuel leaks prior to connecting wiring to the battery or connecting a battery charger to the batteries or to the AC power.

ALWAYS inspect battery compartments before connecting battery charger to batteries and while battery compartments are ventilated. Battery compartment lids should always be open to ensure no explosive hydrogen gas is trapped in the compartment.



WARNING

Batteries produce hydrogen and oxygen gases when being charged. These explosive gases escape through the vent/fill caps and may form an explosive atmosphere around the battery if the ventilation is poor. This gas may remain around the battery for several hours after charging. Sparks or flame can ignite the gas and cause an explosion.

H. FUELING INSTRUCTIONS

1. Secure boat to dock.
2. Boats on trailers need to be on a level surface to prevent air pockets.
3. Switch off all engine(s), pumps, lights, etc. that could produce a spark.
4. Do not smoke, strike matches, or throw an electrical switch.
5. Make certain all passengers are ashore.
6. Be sure the proper type and grade of fuel as recommended by your engine owner's manual is used.
7. Determine how much fuel is required to avoid overflow.
8. Ensure that a fire extinguisher is readily available.
9. Insert the fuel supply nozzle, keeping it in contact with the fuel fill deck plate to guard against static produced sparks.
10. Stand away from the fuel tank vent/fill during fueling. Splash-back may occur which could cause a fire hazard.
11. Make a habit of inspecting the bilge after pumping 5-10 gallons of fuel for any signs of leakage. If no problems are detected, resume fueling.
12. DO NOT top off fuel tank. Allow room for thermal expansion, to prevent fuel from sloshing out the vent. Allow no more than three automatic click-offs when filling.

I. AFTER FUELING

1. Replace all fill caps securely.
2. Wipe up any excess fuel immediately.
3. Determine that there is no odor of gasoline in the bilge, before turning on lights, pumps, or starting engine.



WARNING

Spilled fuel is a fire hazard. DO NOT overfill or overflow the tank, or allow fuel spills into the hull or bilge. If spillage occurs, clean up immediately and dispose of soiled rags in a proper container.



WARNING

Operating, servicing and maintaining a recreational marine vessel can expose you to chemicals including engine exhaust, carbon monoxide, phthalates, and lead, which are known to the State of California to cause cancer and birth defects or other reproductive harm. To minimize exposure, avoid breathing exhaust, services your vessel in a well-ventilated area and wear gloves or wash your hands frequently when servicing this vessel. For more information go to www.P65warnings.ca.gov/marine.

YOUR LIVEWELL AERATION SYSTEM

The livewell aerator system in a Ranger boat is designed to supply the water and oxygen necessary to the survival of your catch. This patented system not only allows fresh water to be pumped in through the aerator supply line(s), but also permits recirculation and aeration at any speed of boat operation.

The recirc position (with aerator running) will only recirculate what water is in the well. It does not bring in any fresh water. This position provides a more positive seal and is good to use if you are going to transport live fish in the well.

The auto position also holds the water in the well and in conjunction with the aerator will allow a mix of fresh water intake and recirculate existing water. This would be the normal position for a day of fishing. The empty position is just that, to empty the water from the well.

On models without digital switching, the livewell aerator timer located on the driver's console, controls the off time of the aerators when the pump switch is in the automatic position. The timer starts and stops the pump at intervals determined by the setting on the timer. Full counterclockwise is minimum off time and full clockwise is maximum off time. To have the aerator pumps run continuously, set the pump switch to the manual position.

Fig. 2

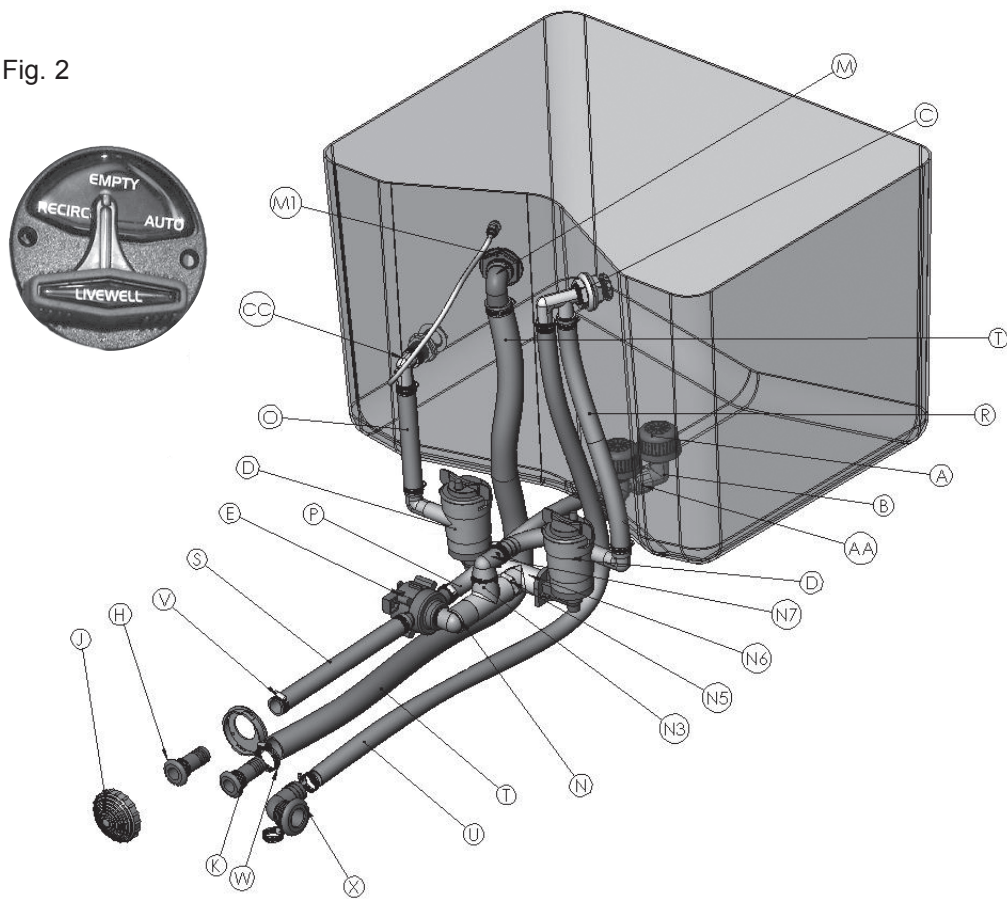

LIVEWELL PUMP-OUT

Your new Ranger may be equipped with a livewell pump-out system. To use this pump out feature, put the livewell control valve in the recirc position and pull out on the aerator spray head. Turn on the aerator and the water in the well will be emptied. To fill the livewell and resume normal operation, push the aerator spray head in and set the livewell valve to the auto position.

Pump-Out Valve Operation

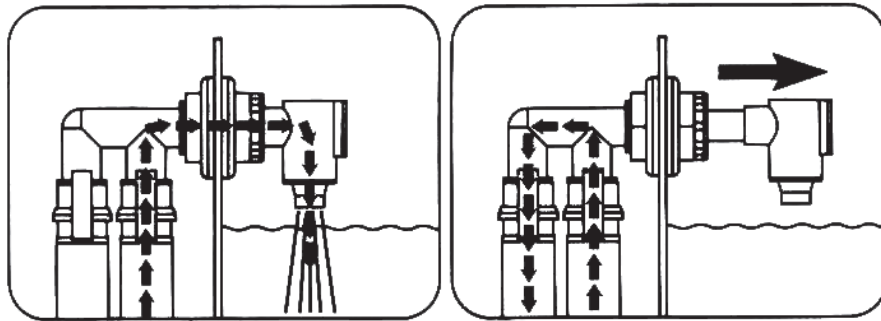

To pump-out, pull the Power-Nozzle aerator head to position shown. **NOTE: Be sure you are operating in recirculation mode.**

LIVEWELL PLUMBING ASSEMBLY

ITEM NUMBER	PART NUMBER	DESCRIPTION
AA	7415915	3/4" x GHT Swivel Female Insert
X	7100111	90 Deg. Black thru Hull 3/4"
W	7843112	5/8" - 1-1/2" Hose Clamp HF 16SS
V	7843092	Clamp, 1/2-1" Hose, HF 10SS
U	7400262	3/4" blk Spiral Reinf Wtr Hose
T	7400225	1-1/8" ID Blk Bilge Hose
O, P, R, S	7400262	3/4" Blk Spiral Reinf Water Hose
N		PVC ASSEMBLY
M1	7100162	1-1/8" Closed Cell Neop. Gasket
M	7100125	Black 90 Deg 1-1/8" Elbow W/Nut
K	7100110	1-1/8" Black Thru Hull Grommet
J	7100118	Transom Mt L/W Screen (2 pc-sml)
H	7100112	Black 3/4" Thru Hull Straight
	5900006	Actuator (Center Empty) Livewell
E	5903070	Actuator Valve "Center Empty"
D	6000057	Pump, Aerator, 750GPHW/90DG ELB
CC	7415855	Venturi Air Aeration Sys Kit
C	6000050	Pump-Out/Aerator Combo
B	7415816	3/4 Male NPT x Male GHT Elbow
A	7100130	Filter, L/W, Int, Mesh

LIVEWELL OPERATING INSTRUCTIONS

- (1) With boat in the water.
- (2) Install drain plug or overflow pipe in livewell to hold water. Pull to drain.
- (3) Be sure hi-speed pick-up valve is open and filter is securely tightened and positioned horizontally with boat bottom (prevents air locks). Aerator head valve (in livewell) should be open.
- (4) Battery selector switch turned to battery used, main breaker in on position.
- (5) Sometimes it may be needed to drive the boat forward if pump has an airlock when initially putting the boat in off a trailer.

MAINTENANCE TIPS FOR AERATOR SYSTEM

- (1) Remove screens only for flushing aerator system.
- (2) Keep screens in place for cleaning and during operation. Replace damaged or broken screens immediately.
- (3) Do not exceed the recommended fuse size on the aerator pumps (a larger fuse WILL NOT make a stronger aerator system!).
- (4) Lubricate pivot on livewell control cable periodically using light weight machine oil.
- (5) Continual operation of pump (especially dry) will damage pump. Be sure aerator switches are “off” when storing, etc.

TROUBLESHOOTING

■ Pump runs, but will not pump water:

- ⇒ Entrapped air pocket around pump impeller has “air locked” pump. With valve in “fill” position, back boat up slowly to expel entrapped water.
- ⇒ On Saltwater models, be sure high speed pickup valve is open (handle in line with valve) and drive boat forward to expel entrapped air.
- ⇒ Grass, sticks, or other debris have clogged the filters or cavity around the pump impeller, restricting water flow to pump. Clean screens, or remove screens and flush system with garden hose using moderate pressure.
- ⇒ On Saltwater models, close the valve, unscrew filter, clean filter element and reinstall. Open valve.

■ Pump will not run (no “hum” is heard):

- ⇒ Make sure switch is in the “Manual” position (in “Automatic” the pump could be working, but in off time).
- ⇒ Check master breaker switch in the rear compartment.
- ⇒ Check fuse, breaker or flashing LED light on digital switching models. Replace or reset as necessary.
- ⇒ Check wire connector at pump.
- ⇒ Replace pump.

■ Livewells will not hold water in “Fill” position.

- ⇒ Flush system to clear debris from livewell valve.
- ⇒ Check cable to valve connection for proper adjustment.
- ⇒ Remove cable, put water in livewell to see if well will hold water with cable removed. If so, adjust cable to match actuator arm.
- ⇒ Remove valve and disassemble. Clean inside of valve with warm soapy water and inspect flappers for nicks, cuts and abrasions. Replace flappers if necessary.

On Saltwater models, be sure drain plug or stand pipe is installed.

2350/2510 BAY PLUMBING

The Leaning Post Bait Well aerator pumps are under the rear lid opening (2350) or rear seating flip up lid (2510). The numbers on the pumps should match the switches. The 2350 has one aerator pump, 2510 has two aerator pumps (#2 aerator pump has the raw water washdown intake and optional rear bait well, adjust spray head(s) to control or shut off flow to bait well(s)).

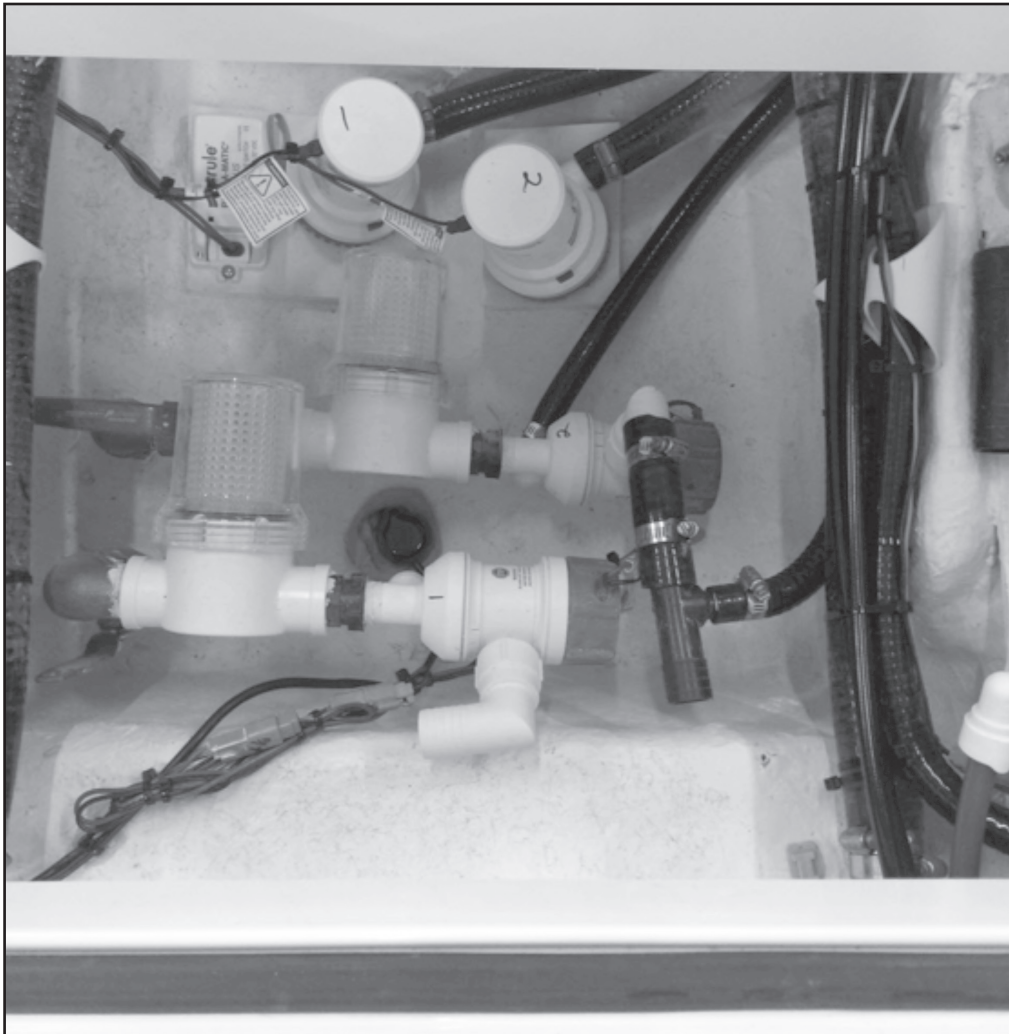

Operation Instructions of your Aeration System:

- 1: Open brass valve(s) of the aerator(s) you wish to use, be sure filter is clean and securely tightened and positioned horizontally with boat bottom (prevents air locks).
- 2: Close valve when cleaning filter or servicing pump.
- 3: Install either drain plug (or push in screen, if running the system continuously or wanting to keep water level lower). Both fittings are supplied with boat in the box containing the paperwork.
- 4: Adjustable spray heads to control idea flow rate. (Under certain conditions, suction in the bait well may cause difficulty opening the lid)
- 5: Refer to page 21 for troubleshooting problems.

Your Livewell Aeration System

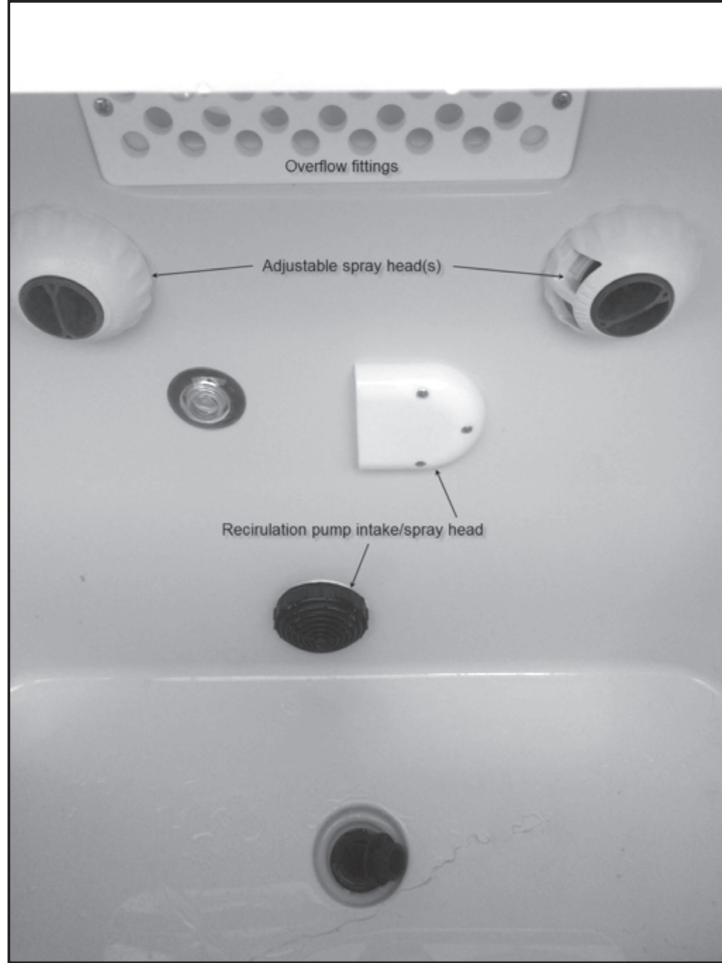

Your Livewell Aeration System

The boat comes standard with 2 large capacity bilge pumps. Each one has a manual switch with one connected to a float for automatic operation. The bilge pump float is connected directly to the battery power source (10 Amp inline fuse), so even if the battery switch is in the off position, the automatic bilge pump will work.

On the port side of the rear deck is the fill cap for the fresh water washdown. The tank has an 8 gallon capacity. On the port side of the leaning post is the fresh water washdown spray head and on the port stern of the cockpit wall inside the door is the raw water washdown fitting.

On the front deck in the center is the fish box. To drain, go into the front cockpit rope/net storage locker and you will find the brass shut-off valve for the fish box drain. Keep this in the closed position, unless draining the fish box.

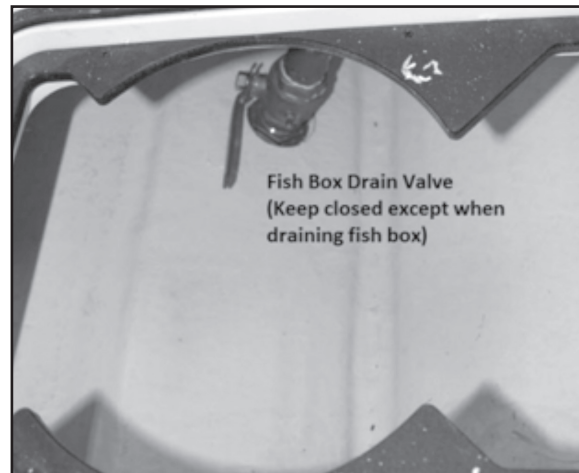
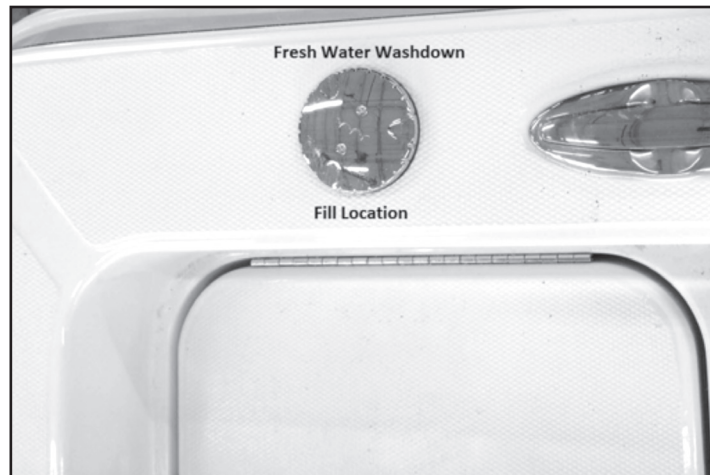

STEERING AT CONSOLE

 **WARNING** The steering in your boat is one of the most important items and should be checked by the driver every time the boat is used. You should school yourself and make it a habit to check the steering methodically. Loose or worn steering could lead to an accident causing injury or death.

Your new Ranger may be equipped with Teleflex hydraulic steering.

This system is designed to help reduce engine torque felt at the wheel (see Fig. 3, page 27), while providing excellent steering response. However, this is not to be interpreted in any way as an “Automatic Pilot”. A firm grip on the wheel is required at all times. Read the steering owner/installation manual for maintenance instructions.

 **NOTICE** Due to the special valving in the hydraulic helm the steering wheel may not be in the same position each time the steering is returned to center. This is normal operation and should be no cause for alarm.

Other Ranger models may be equipped with no feed back steering. This is mechanical steering that is designed to help reduce engine torque, felt at the wheel, to a minimum. However, a firm grip on the steering wheel is required at all times.

You should familiarize yourself with the feel of the steering at various speeds and trim settings. **NEVER** exceed speeds beyond your comfort level.

 **WARNING** The driver must always keep a firm grip on the steering wheel. Failure to do so could lead to an accident causing injury or death.

TELEFLEX HYDRAULIC STEERING

Remove, clean and grease the support tube annually with quality marine grease.

Check the steering fluid level in the helm. It should be maintained at no less than 1/2” and no more than 1/8” below the bottom of the filler cap threads. Be careful not to overfill.

Replace any hoses showing signs of wear and remove the cause or re-route hoses.

Check fittings and seal locations for leaks/damage and service as necessary.

If you have installed a jack plate, make sure that there isn’t any interference between the jack plate and your steering cylinder. If there is interference, it may occur during full tilt. Lift restrictors or a Tilt Stop Switch should be installed. Please consult your engine manufacturer.

 **WARNING** Failure to comply with maintenance checks may result in loss of steering, causing property damage and/or personal injury. Maintenance requirements will vary depending on usage and climate. Bi-annual inspection by a qualified marine mechanic is required.

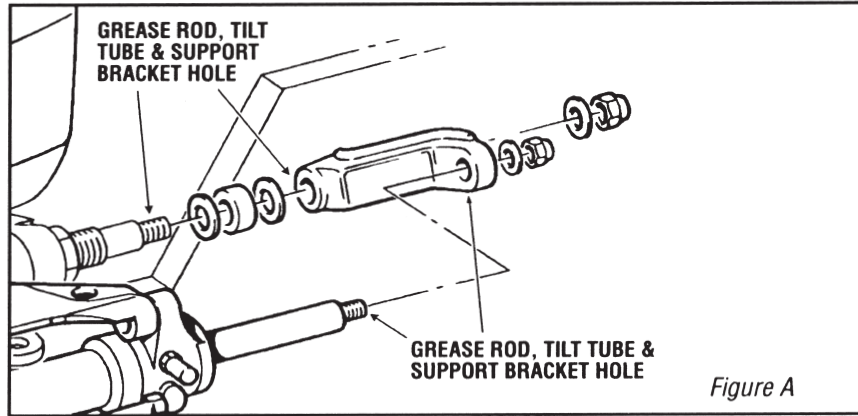

CAUTION Grease rod, tilt tube and support bracket holes once a year.

WARNING Engine mounting location preset at the factory. Adjustments can result in damage to control system equipment. Control system damage can result in serious injury or death. Regularly inspect control system and clearances at all trim angles.

For complete installation and troubleshooting information, please refer to your SeaStar installation instructions, Book 1.1 (Part # 296784).

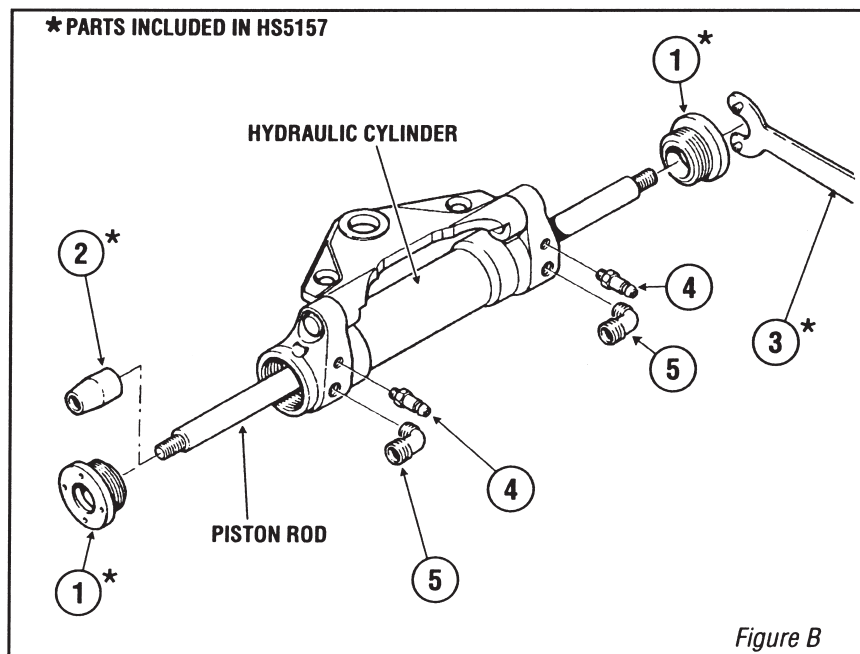

**SEAL REPLACEMENT KIT (PART # HS5157) FOR:
FRONT MOUNT CYLINDER (PART # HC5345)**

ITEM	PART #	QUANTITY	DESCRIPTION
1	797021	2	Seal Gland Only
2	745920	1	Seal Gland Assembly Guide Tool
3	745525	1	Pin Wrench Only
4	828980	1	Bleeder Fitting
5	600601	1	Elbow Fitting

SEAL KIT # HS5157

ITEM	PART #	QUANTITY	DESCRIPTION
1	797021	2	Seal Gland Only
2	745920		1 Seal Gland Assembly Guide Tool
3	745525	1	Pin Wrench Only

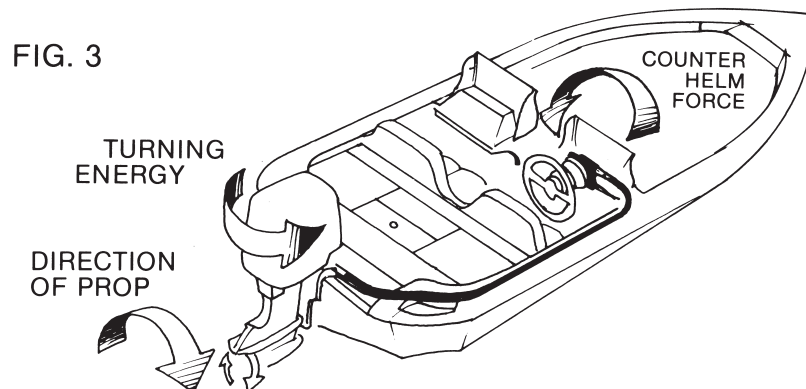

STEERING CONNECTIONS AT ENGINE

The steering may be connected at the engine by a method similar to the ones shown in Figures 4 & 5 (page 28). Figures 4 & 5 show maintenance and checkpoints that should be regularly inspected.

CAUTION Check all engine to transom mounting bolts and torque to engine manufacturer specifications after the first 10 hours of use and every 30 hours thereafter. Failure to do so could lead to transom and engine damage.

CAUTION See your authorized marine dealer for specific information concerning maintenance of engine connections.

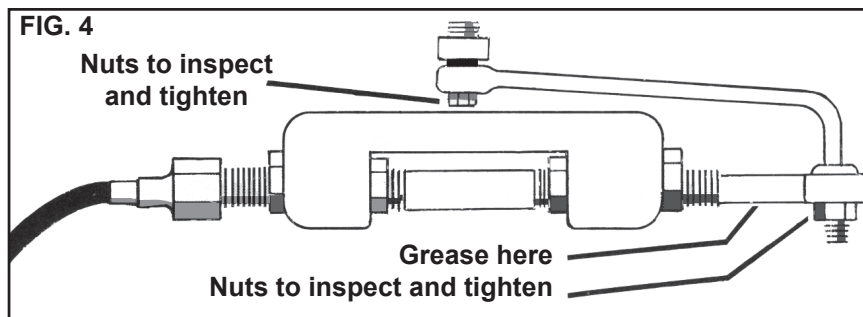

CAUTION

See engine owner's manual for proper greasing and maintenance of engine link rod and steering kit.

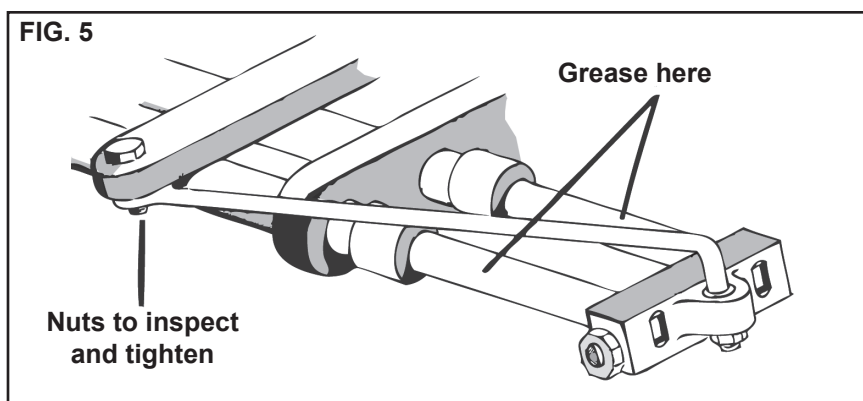

YOUR BOAT'S FINISH... MAINTENANCE AND REPAIR

The gelcoat (color) used on your Ranger® Boat is of the highest quality available today. To keep it looking new and in good condition these tips will prove helpful.

- A light duty rubbing compound (available at most auto parts stores) is recommended for stains such as mold, water lines on the hull, fine scratches on finish or just to bring back that "look new" shine.
- Automotive wax or polish is good for preserving the shine and building an "armor coat" to prevent scratches and will also help protect hull while in wet storage.
- A boat cover (which is available from your Ranger dealer) is also a wise investment to help prevent damage while the boat is at home or on the road.



NOTICE

Do not use acids or other strong chemicals to clean your boat.

Careful as you may be, you will get that scratch from the dock or beach that will need some attention. Most Ranger dealers are equipped to do fiberglass repair, and large jobs are better left to the experts. However, minor scratches, chips, and gouges may be repaired by you. These instructions are to repair solid color gelcoat only, not poliflake:

1. Using masking tape, tape around damaged area slightly larger than actual flaw, keeping area to be repaired as small as possible.
2. Remove any damaged glass or gelcoat. Sand damaged area and all surface inside tape, enough to rough up area and remove shine, using #220 grit dry sand paper.
3. Wash area with a solvent such as acetone and allow to dry.



WARNING

These materials are very flammable. Do not smoke or use electric equipment while using them. Improper handling could result in an explosion resulting in injury or death.

4. Using Ranger touch-up gelcoat or putty only, thoroughly mix 1% catalyst (MEKP) with desired amount of gelcoat or putty.



NOTICE

Gelcoat will not cure by itself. You must use a catalyst.

5. With a putty knife, trowel catalyzed gelcoat in desired area, leaving it slightly higher than the original surface to allow for shrinkage.
6. When patch has dried, remove masking tape and carefully sand back to the original shape using #600 grit WET sandpaper. Then buff with a light duty buffing compound.

NOTE: Area may have to be filled more than once due to shrinkage.

NOTE: Due to different dye lots the color may vary somewhat. However, we take all the steps to keep our color consistent.



NOTICE

Do not hold buffer in one area long enough to burn gelcoat.



NOTICE

Do not sand metalflake surfaces. A different procedure is used to repair these finishes. You should contact your Ranger dealer for more information.

YOUR POWER PEDESTALS

A “power pedestal” is a nitrogen gas filled steel cylinder that is used to raise and lower the fishing seats mounted on the forward and aft casting platforms. This enables you to select the proper seat height for comfort in any fishing situation. Pushing the empty seats all the way down helps to provide an unobstructed viewing area around the boat when underway.

To raise the seat, simply lift your weight slightly off the seat while raising the seat actuating lever simultaneously. To lower the seat, keep your weight on the seat and lift the lever up.

These pedestals are constructed to the highest standard of workmanship and will give years of trouble-free service. A minimum amount of care will insure proper operation. Periodically apply a light weight oil (like household “3-in-1” oil) to the power unit piston. Take care not to over stress the pedestal by placing excessive

strain on the seat and power unit while it is extended into the full up position. Always lower the seat to the full down position when the boat is underway. We recommend that the seat and pedestal be removed from the front casting deck and remounted into the special base mounted in the front of the deck floor when running. Should your boat not have the additional base, the front fishing seat should be removed and securely placed in the floor of the boat.

Your power pedestals are warranted for three years against defects in materials and workmanship. Should a pedestal fail, return the unit to Springfield Marine, Attention: Warranty/Repair, Hwy. 160, P.O. Box 588, Nixa, Missouri 65714, or call 417-725-2667. Repairs not covered by warranty will be charged at their regular rate.

! WARNING Power unit is under pressure. Do not attempt to disassemble it or tamper with it in any way. Improper handling could result in severe injury or death.

If your power pedestal will not remain in position, either up or down, you may need to make a minor adjustment to the air cylinder that causes the pedestal to be raised up and down.

With your chair removed from the pedestal, use a Phillips #0 screwdriver to move the adjustment screw as shown in the accompanying diagram.

! WARNING To avoid serious or fatal injury, do not occupy raised fishing seats when boat speed exceeds 5 MPH.

If your seat will not raise up to the proper height, adjust the screw approximately 1/4 (one-quarter) turn in a counter-clockwise direction and try the pedestal again.

If your seat will not remain in the upright position, move the adjustment screw approximately 1/4 (one-quarter) turn in a clockwise direction.

NOTE: You may need to fine-tune your pedestal by moving the adjustment screw a bit more in one direction or the other.

Adjust the screw in the end of the air cylinder as needed

Section view of swivel

Handle

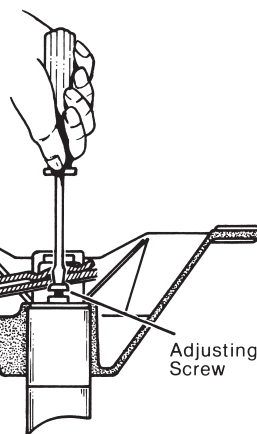

Adjusting Screw

**ADJUSTING AIR RIDE HANDLE
Prior To Installing Seat**

**NON-ADJUSTABLE
SNAP LOCK SWIVEL**

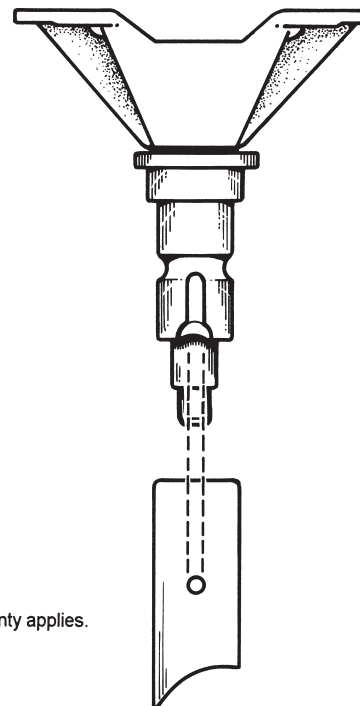

* Non-Adjustable pedestals are standard on some models, the same warranty applies.

KEY LOCKS, CARPET AND UPHOLSTERY

Your Ranger® boat has been equipped with top-quality marine grade key locks to secure your storage areas. Should your boat be subjected to use in or near saltwater, care should be taken to flush the locks out thoroughly with fresh water to prevent corrosion.



NOTICE

The storage locks on your new Ranger are adjusted at the time of manufacture and may require periodic adjustment during the first year of service. This is considered normal and is no cause for alarm.

The carpet in your boat is the finest grade available. Although the special backing is RESISTANT to oil and gasoline, spills should be removed with soap and water to maintain the good looks and extend the carpet life. A car-wash is suitable for washing and rinsing your carpet as well as cleaning the fiberglass surfaces.



NOTICE

The popular and effective “fish scents” that are commonly sprayed on lures today will cause deterioration of the carpet backing. Use caution to spray these formulas well away from your boat carpet! Any spills should be cleaned up promptly.

Your Ranger upholstery is top-grade marine vinyl. Naturally, the suppleness and color fidelity of the upholstery is best maintained by storing your boat out of direct sunlight. Cleaning and conditioning of your upholstery is best accomplished with an approved, top-quality vinyl cleaner. To loosen stubborn soil or embedded dirt in textured surfaces, use a soft bristle brush, your approved cleanser, followed by wiping with a damp sponge. See specific suggestions for cleaning of upholstery on pages 31 and 32.



CAUTION

Do not use acetone, paint remover or other strong solvents on boat's upholstery.

CLEANING UPHOLSTERY

For general purpose cleaning, use Fantastik, or warm water with a mild dish soap such as Dawn or Ivory. Gently scrub with a small soft bristle brush.

For dirt build-up, let soak for approximately 10 minutes, then gently scrub with a soft bristle brush. For specific stain removal, refer to the chart on page 32 or the staining agent's stain removal instructions.



CAUTION

DO NOT use Formula 409 (the bottle states the product should not be used on vinyl.)

DO NOT use kerosene, gasoline, or acetone, as they will remove the protective marine top coat on your vinyl.

DO NOT use any silicone based protectants. They will extract the plasticizers, leaving the vinyl hard and brittle, and eventually cracking will occur.

Key Locks, Carpet and Upholstery

USE	DO NOT USE		
Dish Soap (Dawn, Ivory) Fantastik 303 Protectant	Formula 409 Murphy's Oil Soap Simple Green Orange 88 Degreaser	ArmorAll Top Kote Son-of-a-Gun DC Plus Roll-Off	Bleach/Baking Soda Turtle Wax Tar Remover APCO Sealant Harbor Mate

Certain household cleaners, powdered abrasives, steel wool, and industrial cleansers can cause damage and discoloration and are not recommended.

Dry cleaning fluids and lacquer solvents/acetone (for example, nail polish remover) should not be used as they will remove printed pattern and/or gloss.

Waxes should be used with caution as many contain dyes or solvents that can permanently damage the protective coating.

This chart contains methods for removing common stains and soils:

- A. Medium-soft brush, warm soapy water. Rinse. Dry.
- B. Household cleaner such as Fantastik.
- C. One tablespoon ammonia, one-fourth cup hydrogen peroxide, three-fourths cup water applied with medium soft brush. Rinse. Dry.
- D. Wipe or scrape off excess (chill gum with ice first).
- E. Denatured Alcohol. Rinse. Dry.
- F. Follow instructions of stain agent manufacturer.

	STEP 1	STEP 2	STEP 3
Ballpoint Ink*	E	B	A
Chewing Gum	D	B	A
Coffee, Tea, Chocolate	B		
Crayon	D	B	
Grease	D	B	F
Household Soil	A	B	
Ketchup	A	B	
Make Up (Lipstick, eye shadow etc.)	A	B	
Mildew, Wet Leaves*	C	B	A
Motor Oil	B		
Paint, Dried Oil Base	D	B	A
Paint, Fresh Oil Base	D	A	F
Paint, Latex	A	B	F
Permanent Marker*	E	B	C
Shoe Polish*	D	B	F
Spray Paint	B	F	
Suntan Lotion*	A	B	
Tar/Asphalt	D	B	
Yellow Mustard	A	B	C

* Suntan lotion, tree pollen, wet leaves, and some other products contain dyes that stain permanently.

ADDING ACCESSORIES TO YOUR BOAT...

The bow section of the gunwale is properly reinforced for installing such accessories as trolling motors and depth sounders. We recommend through-bolting all trolling motors, anchor davits and other heavier accessories. Normally 1/4" stainless steel bolts with self locking nuts and 1-1/4" fender washer will do the job. Lightweight depth sounders or similar equipment and hardware can be installed using #8 or #10 stainless steel screws. Always drill a pilot hole through the fiberglass (just smaller than the screw you're going to use) and use a counter sink to chamfer the pilot hole before attempting to install a screw. This lessens the chance of "stripping" the hold or chipping the gelcoat around the hole.

If additional instruments are desired on the console, holes may be drilled using a hole saw of the proper size.



NOTICE

Use Marine Sealer around all screws installed into transom or floor of boat. When installing screws below water line, be sure sealer used is recommended for such.

When installing additional electric accessories, always use the proper gauge (size) wire recommended for that item. Insure that the proper size breaker or fuse is used. "Splicing" into another accessory's power supply could overload the circuit and should be avoided.



CAUTION

Always disconnect the positive and negative leads from the battery terminals before installing, removing, servicing, or troubleshooting any part of the electrical system.

HOOK UP OF TROLLING MOTOR LEADS:

2 WIRE	RED to Battery	1 (+) positive
36 VOLT	BLACK to Battery	3 (-) negative
SYSTEM	JUMPER 1(black sleeve) to Battery	1 (-) negative
	JUMPER 1(red sleeve) to Battery	2 (+) positive
	JUMPER 2 (black sleeve) to Battery	2 (-) negative
	JUMPER 2 (red sleeve) to Battery	3 (+) positive

2 WIRE	RED to Battery	1 (+) positive
24 VOLT	BLACK to Battery	2 (-) negative
SYSTEM	WHITE from Battery	1 (-) negative
	to Battery	2 (+) positive
2 WIRE	RED to Battery	1 (+) positive
12 VOLT	BLACK to Battery	1 (-) negative
SYSTEM		



CAUTION

Hooking up leads to trolling motor in any other manner could result in severe damage to both batteries and panel.

Breakers are circuit protection (50 amp 12 volt) for the positive (+) leads in the trolling motor wiring (bow to stern). A problem in the system could result in the breaker(s) being tripped. Should this occur, the breaker(s) can be reset by pushing the switch. If this occurs again, disconnect battery leads and trace immediately, or take it to your Ranger dealer for repair.

An ignition protected circuit breaker is used for the accessories. Should a breaker trip, simply reset. **This switch should also be in the “off” position when trailering or storing the boat.** It acts as a master switch and turns off all accessories getting their power from the Ranger fuse panel. Remember, engine circuits will not be affected by these breakers/switches, but could have breakers or fuses of their own. Consult your engine owners manual for electrical particulars.

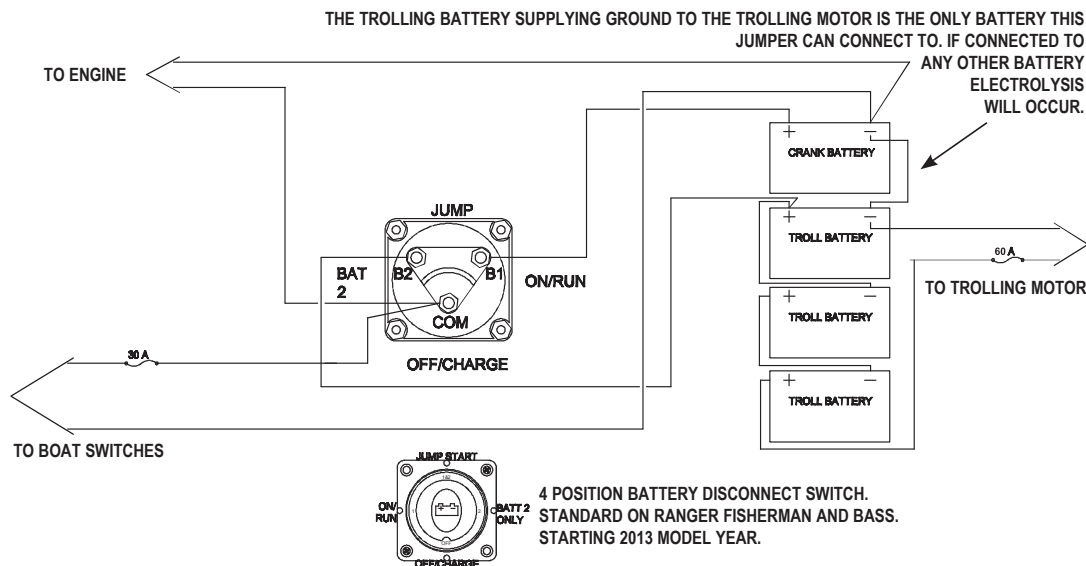

Your new Ranger may have a 4 position battery disconnect switch which functions as noted:

On/run – switch position while boat is in use

Off/Charge – position for storage and charging batteries. Turn switch to this position before connecting battery charger to 110V outlet

Jump Start – combines crank and trolling battery in case extra starting power is needed

Battery 2 – connects to trolling battery only

BATTERY REQUIREMENT

Selecting the right cranking battery for your boat is critical for achieving how you would like to use the boat. Engine manufacturers have specifications for cranking batteries. The specifications will vary depending on horse power. They will have a specification for Cold Crank Amps (CCA) and a Reserve Capacity (RC) rating. The CCA rating will tell you how many amps the battery can supply at zero degrees Fahrenheit. Consult with the engine manual to find out what CCA requirement you need. The RC rating will tell you how long, in minutes, it will take the battery to go from full charge to 10.5 volts with a 20 amp load. Most engines will specify an RC rating of 135 to 182. However, getting a battery with a higher RC rating will allow a longer run time.

Acid Glass Matt (AGM) batteries have advantages over traditional wet cell batteries. AGM batteries will have a longer life and can handle high amperage demands at a lower discharge state. Mercury Verado engines require an AGM battery to be used for a cranking battery.

Trolling motor batteries do not require a battery that can produce a certain CCA. Instead you will want to look more closely at the RC rating. You will want to get a battery with a rating of 180 or higher.

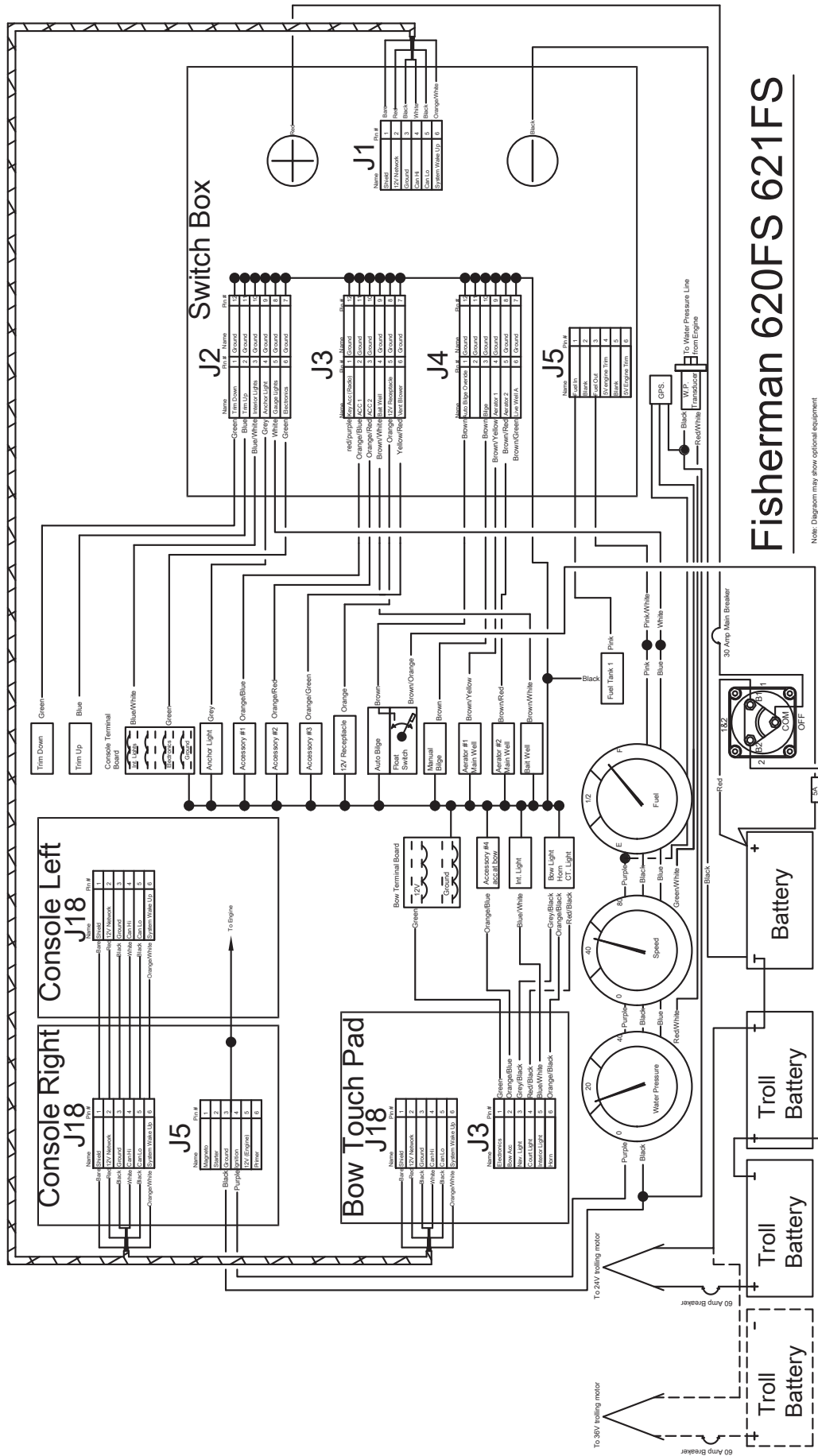

Fisherman 620FS 621FS

Note: Diagram may show optional equipment

SALT WATER BAY BOATS

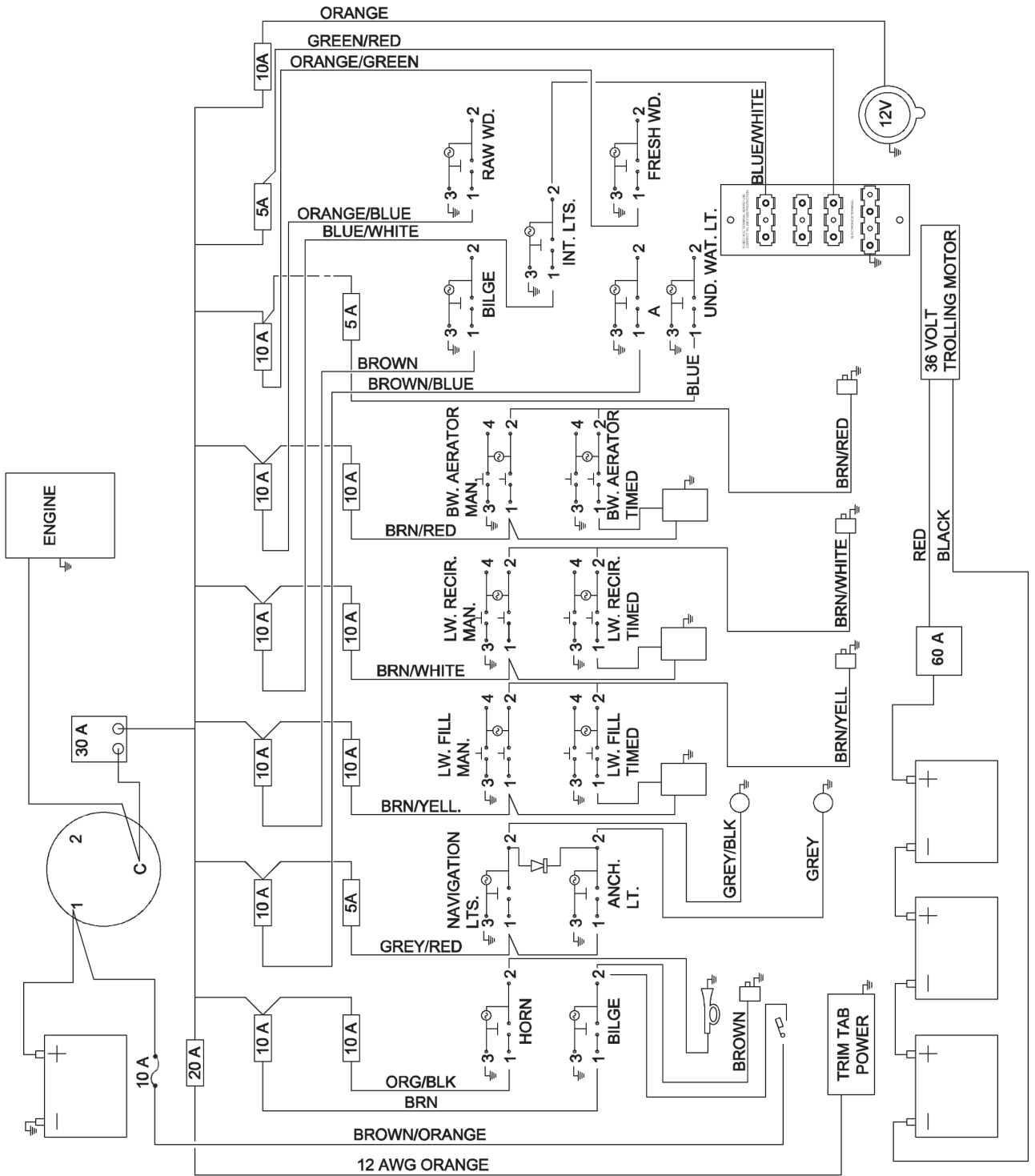

1850, 2050, 1880, 2080

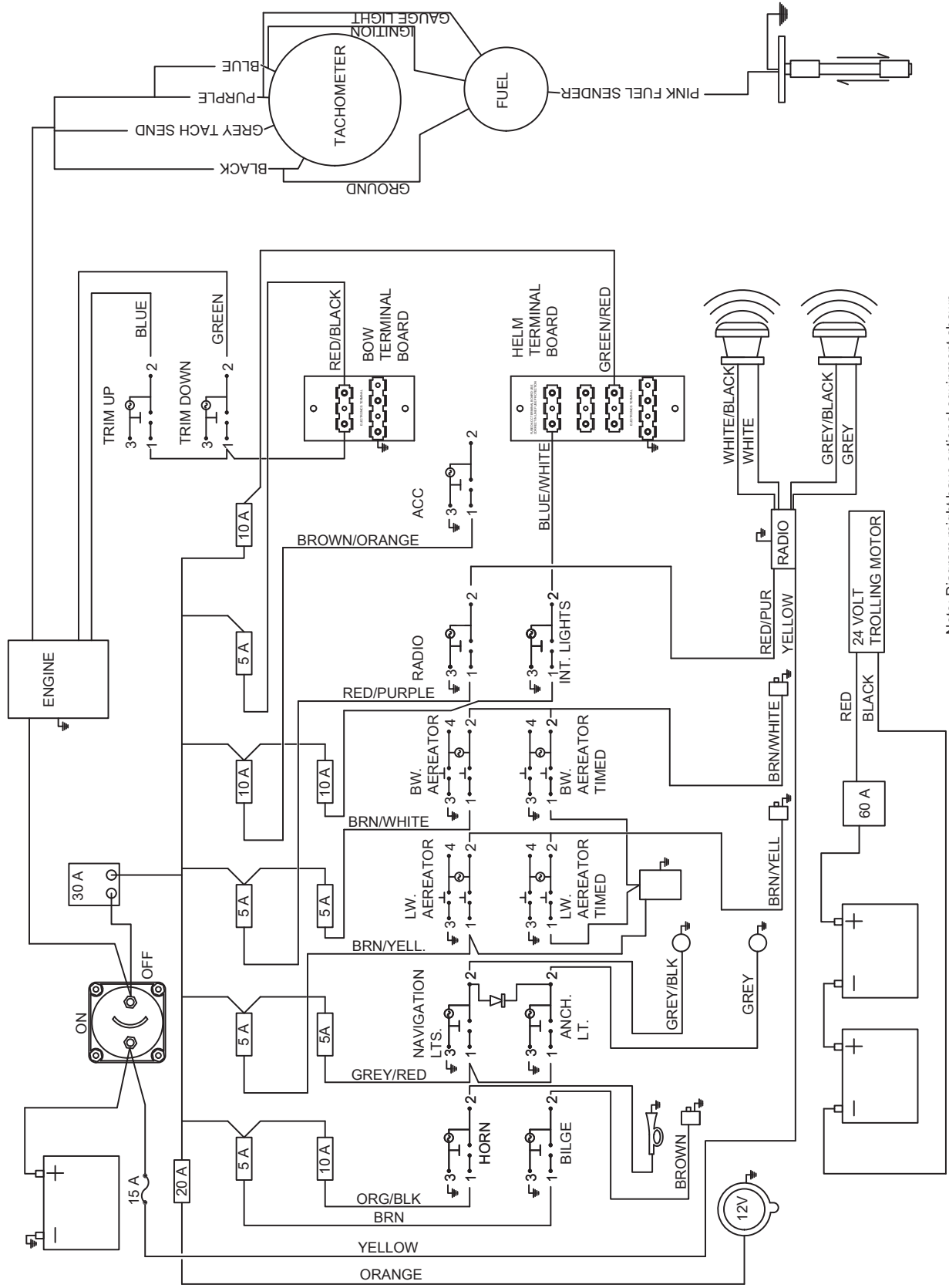

Note: Diagram might have optional equipment shown.

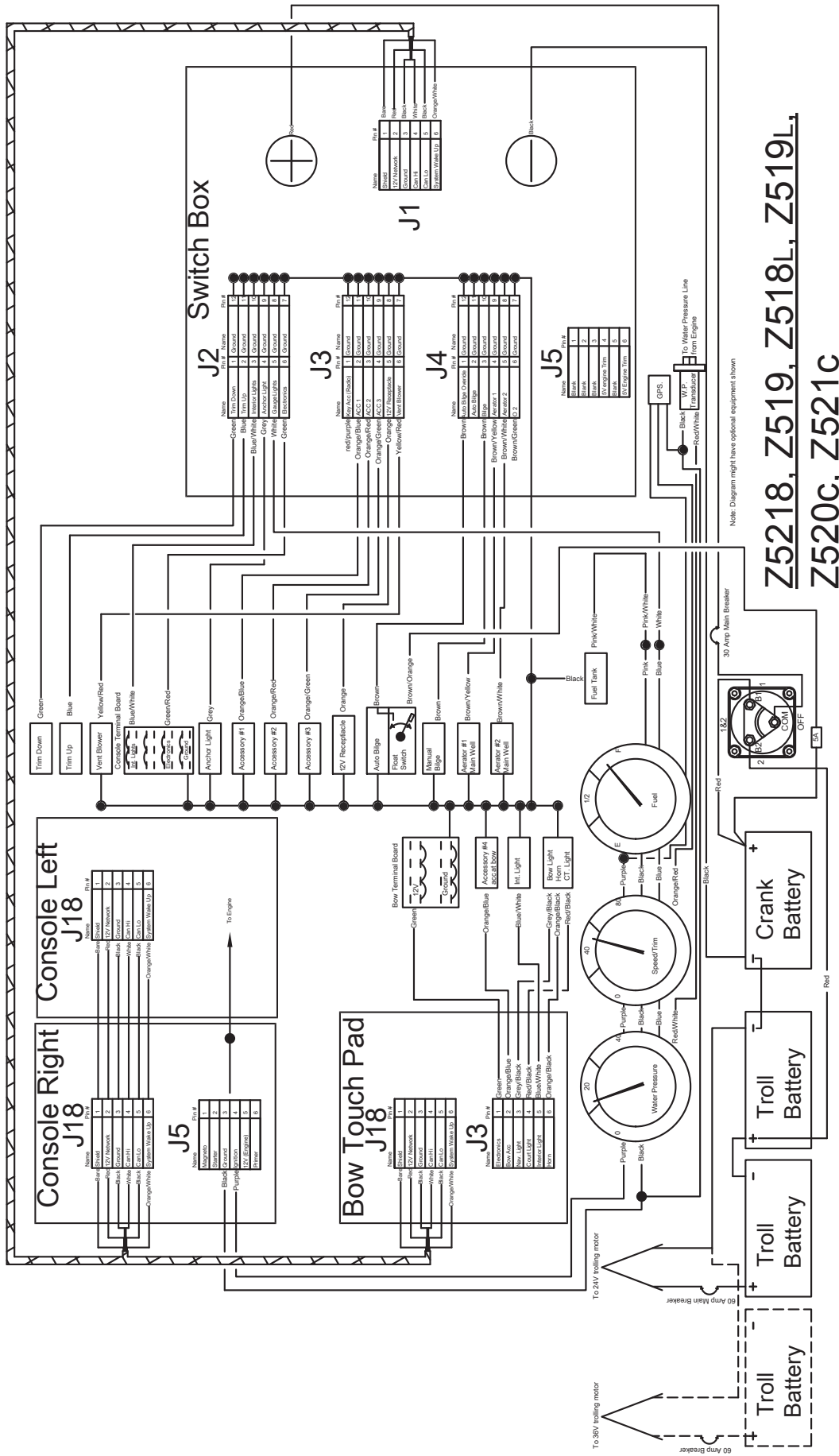

Z5218, Z519, Z518L, Z519L,
Z520C, Z521C

619FS

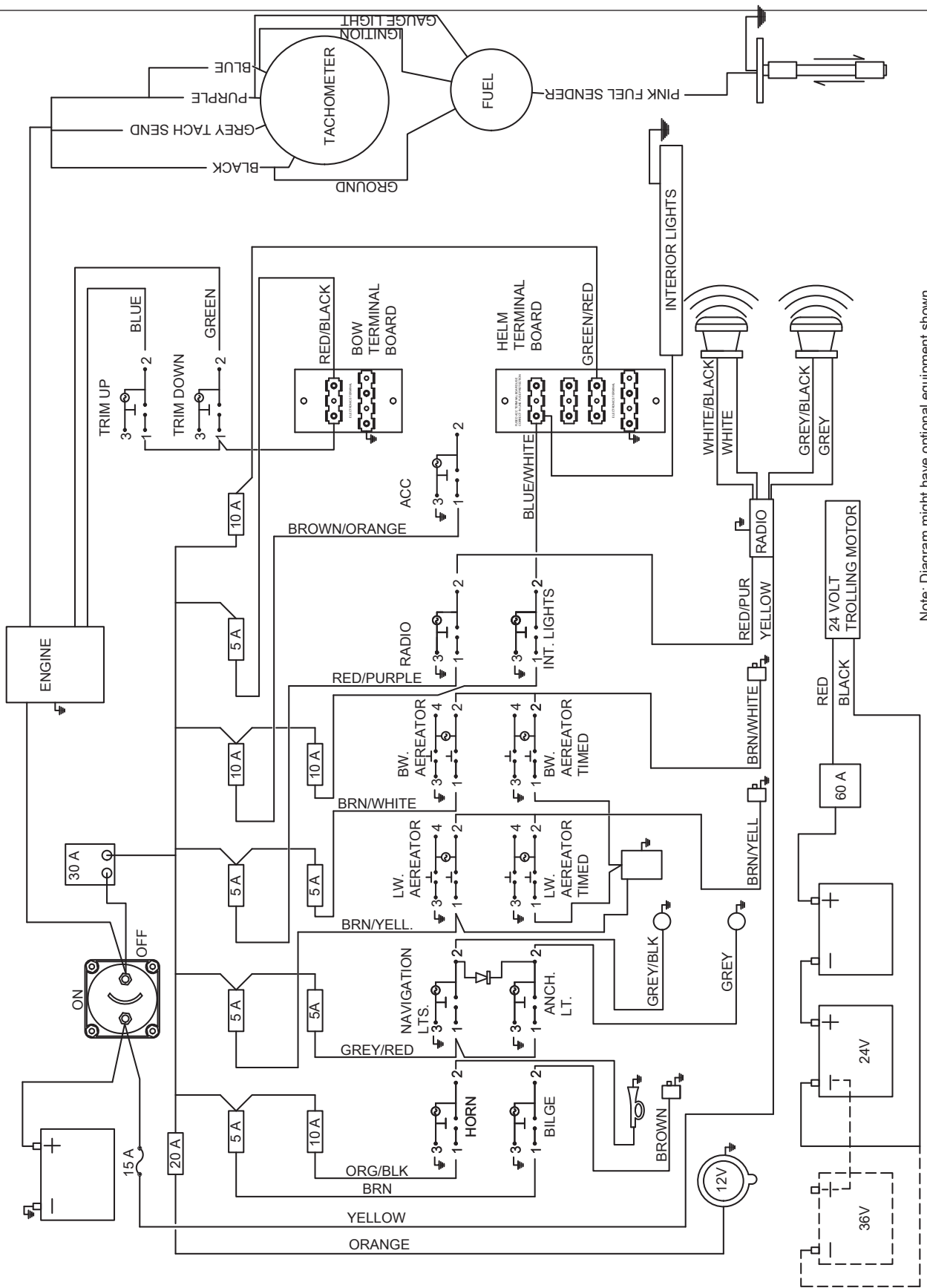

Note: Diagram might have optional equipment shown.

Z-L MODELS SHOWN WITH OPTIONAL EQUIPMENT

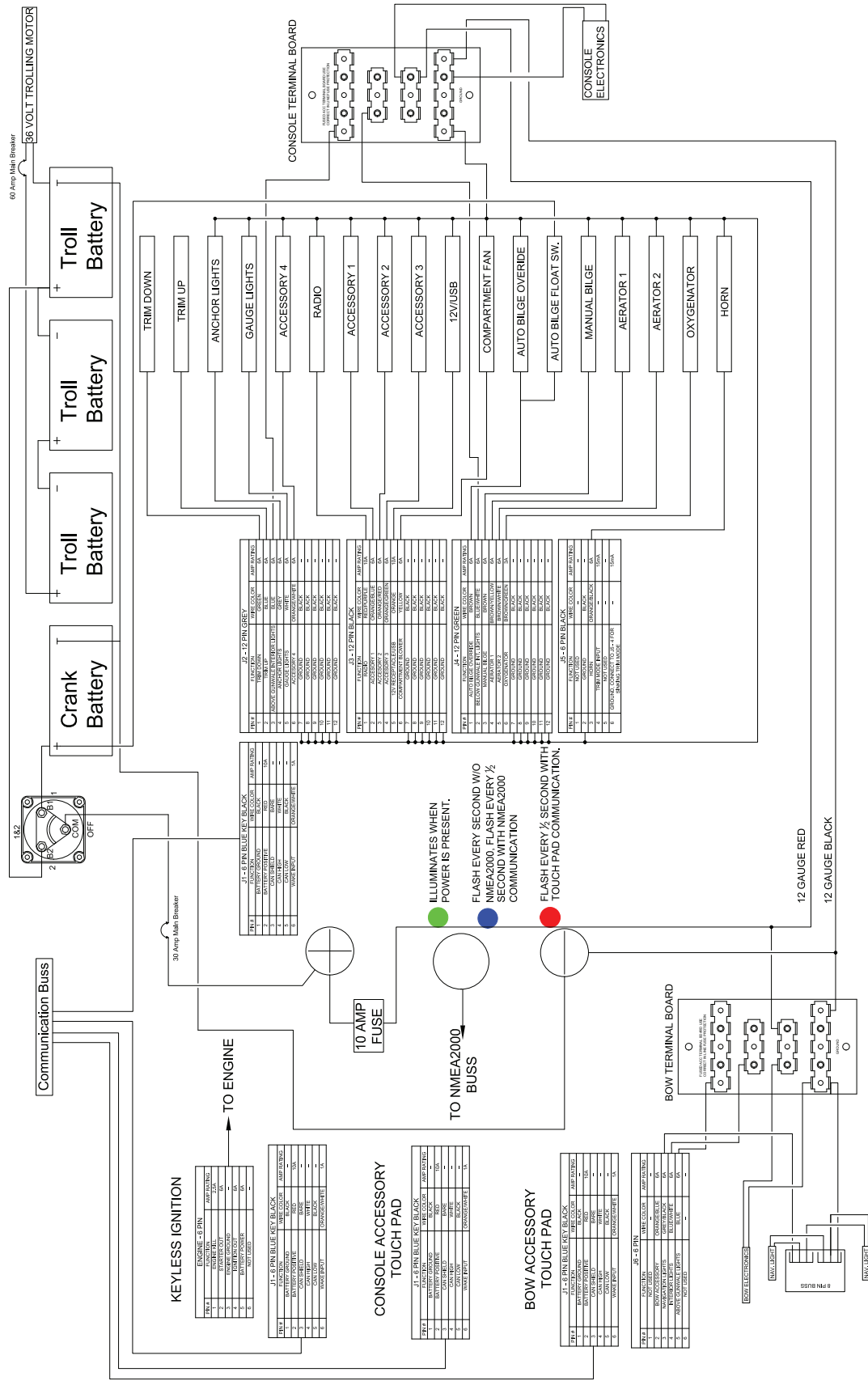

KEYLESS IGNITION

TERMINAL	FUNCTION	WIRE COLOR	AMP POINTS
1	ENGINE +6 PIN	RED	5A
2	IGNITION	BLACK	5A
3	IGNITION	BLACK	5A
4	IGNITION	BLACK	5A
5	IGNITION	BLACK	5A
6	IGNITION	BLACK	5A

11-12 PIN BLUE KEY BLACK

TERMINAL	FUNCTION	WIRE COLOR	AMP POINTS
1	ANCHOR LIGHTS	RED	5A
2	BATTERY POSITIVE	RED	5A
3	IGNITION	BLACK	5A
4	IGNITION	BLACK	5A
5	IGNITION	BLACK	5A
6	IGNITION	BLACK	5A
7	IGNITION	BLACK	5A
8	IGNITION	BLACK	5A
9	IGNITION	BLACK	5A
10	IGNITION	BLACK	5A
11	IGNITION	BLACK	5A
12	IGNITION	BLACK	5A

CONSOLE ACCESSORY TOUCH PAD

TERMINAL	FUNCTION	WIRE COLOR	AMP POINTS
1	ANCHOR LIGHTS	RED	5A
2	BATTERY POSITIVE	RED	5A
3	IGNITION	BLACK	5A
4	IGNITION	BLACK	5A
5	IGNITION	BLACK	5A
6	IGNITION	BLACK	5A
7	IGNITION	BLACK	5A
8	IGNITION	BLACK	5A
9	IGNITION	BLACK	5A
10	IGNITION	BLACK	5A
11	IGNITION	BLACK	5A
12	IGNITION	BLACK	5A

BOW ACCESSORY TOUCH PAD

TERMINAL	FUNCTION	WIRE COLOR	AMP POINTS
1	ANCHOR LIGHTS	RED	5A
2	BATTERY POSITIVE	RED	5A
3	IGNITION	BLACK	5A
4	IGNITION	BLACK	5A
5	IGNITION	BLACK	5A
6	IGNITION	BLACK	5A
7	IGNITION	BLACK	5A
8	IGNITION	BLACK	5A
9	IGNITION	BLACK	5A
10	IGNITION	BLACK	5A
11	IGNITION	BLACK	5A
12	IGNITION	BLACK	5A

13-14 PIN GREEN

TERMINAL	FUNCTION	WIRE COLOR	AMP POINTS
1	ANCHOR LIGHTS	RED	5A
2	BATTERY POSITIVE	RED	5A
3	IGNITION	BLACK	5A
4	IGNITION	BLACK	5A
5	IGNITION	BLACK	5A
6	IGNITION	BLACK	5A
7	IGNITION	BLACK	5A
8	IGNITION	BLACK	5A
9	IGNITION	BLACK	5A
10	IGNITION	BLACK	5A
11	IGNITION	BLACK	5A
12	IGNITION	BLACK	5A

15-17 PIN BLACK

TERMINAL	FUNCTION	WIRE COLOR	AMP POINTS
1	ANCHOR LIGHTS	RED	5A
2	BATTERY POSITIVE	RED	5A
3	IGNITION	BLACK	5A
4	IGNITION	BLACK	5A
5	IGNITION	BLACK	5A
6	IGNITION	BLACK	5A
7	IGNITION	BLACK	5A
8	IGNITION	BLACK	5A
9	IGNITION	BLACK	5A
10	IGNITION	BLACK	5A
11	IGNITION	BLACK	5A
12	IGNITION	BLACK	5A

18-20 PIN GREEN

TERMINAL	FUNCTION	WIRE COLOR	AMP POINTS
1	ANCHOR LIGHTS	RED	5A
2	BATTERY POSITIVE	RED	5A
3	IGNITION	BLACK	5A
4	IGNITION	BLACK	5A
5	IGNITION	BLACK	5A
6	IGNITION	BLACK	5A
7	IGNITION	BLACK	5A
8	IGNITION	BLACK	5A
9	IGNITION	BLACK	5A
10	IGNITION	BLACK	5A
11	IGNITION	BLACK	5A
12	IGNITION	BLACK	5A

21-23 PIN BLACK

TERMINAL	FUNCTION	WIRE COLOR	AMP POINTS
1	ANCHOR LIGHTS	RED	5A
2	BATTERY POSITIVE	RED	5A
3	IGNITION	BLACK	5A
4	IGNITION	BLACK	5A
5	IGNITION	BLACK	5A
6	IGNITION	BLACK	5A
7	IGNITION	BLACK	5A
8	IGNITION	BLACK	5A
9	IGNITION	BLACK	5A
10	IGNITION	BLACK	5A
11	IGNITION	BLACK	5A
12	IGNITION	BLACK	5A

24-26 PIN BLACK

TERMINAL	FUNCTION	WIRE COLOR	AMP POINTS
1	ANCHOR LIGHTS	RED	5A
2	BATTERY POSITIVE	RED	5A
3	IGNITION	BLACK	5A
4	IGNITION	BLACK	5A
5	IGNITION	BLACK	5A
6	IGNITION	BLACK	5A
7	IGNITION	BLACK	5A
8	IGNITION	BLACK	5A
9	IGNITION	BLACK	5A
10	IGNITION	BLACK	5A
11	IGNITION	BLACK	5A
12	IGNITION	BLACK	5A

Z175, Z185

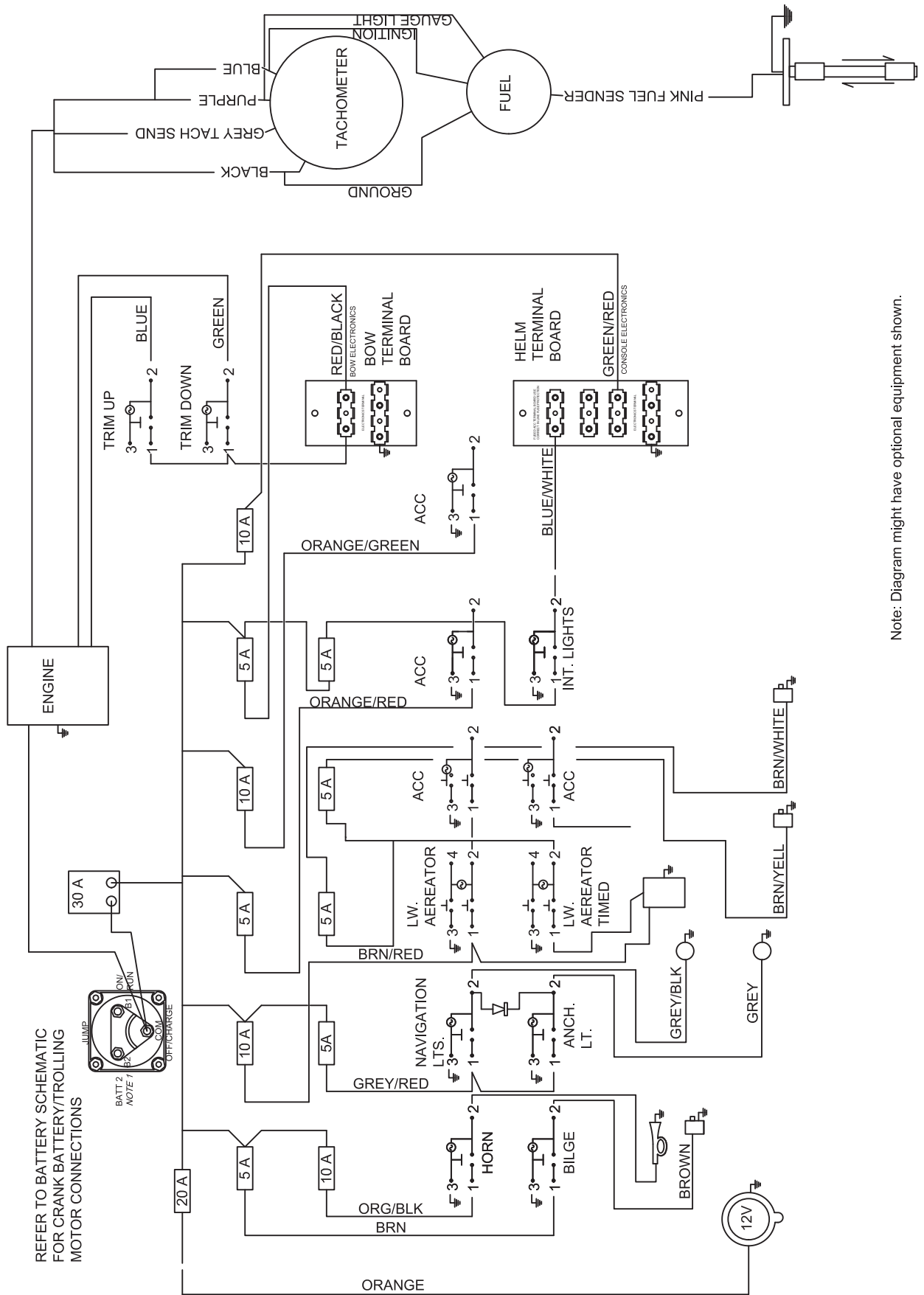

Note: Diagram might have optional equipment shown.

ELECTRICAL SYSTEM

FUSE PANEL INFORMATION

On some models, the fuse panel features plug-in type ATC fuses. The fuses can be easily inspected and replaced. Z Comanche along with certain Fisherman and Saltwater models have no replaceable fuses. Circuits are reset as outlined in that model's Electrical System section. The Panel has a capacity of twelve to sixteen individual circuits. The particular accessory(ies) they operate are shown on the decal on the right side of the fuse panel or back side of the fuse panel cover.



CAUTION

Do not exceed recommended fuse sizes. Always install proper rated fuse when adding accessories to the fuse panel.







CAUTION



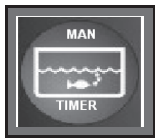

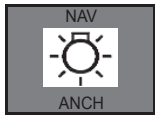
Inspect battery compartment(s) before plugging in AC power to charger. Inspect for loose wires, cracked battery, etc.

To improve the performance of the batteries, turn the master switch or breakers to the off position when the boat is not in use. Electronics, stereos and other items that the boat may be equipped with, could have a current draw even when those items are turned off. If you leave your boat in the water, leave the breaker turned on in order for the automatic bilge pump to have power. If conditions are such that the bilge pump is operating frequently, it will be necessary to check the battery for its state of charge and to charge as needed. On Saltwater models equipped with digital switching, you may leave the main breaker and all cut off switches turned to the off position while the boat is not in use. The auto bilge pump on these models is connected directly to the battery and fused independent of the main breaker.

ROCKER SWITCH EQUIPPED MODELS

Symbols	Type	Function	Operation
	Double Pole Double Throw	Manual for continuous running Live Well Aerator Timer for timed aeration	Manual OFF Timer
	Single Pole Single Throw	Interior lights Compartment lights	Lights On OFF
	Double Pole Double Throw	Nav light is the Red & Green & Anchor Light Navigation Lights Anchor light is Light at rear of boat	Navigation Light OFF Anchor Light
	Single Pole Momentary	Horn	Horn OFF

ROCKER SWITCH EQUIPPED MODELS - CONTINUED

Symbols	Type	Function	Operation
	Single Pole Single Throw	Bilge Pump	Bilge OFF
	Single Pole Single Throw	ACC	Press up to operate an a accessory OFF
	Single Pole Double Momentary	Engine Trim	Trim Engine up OFF Trim Engine down
	Single Pole Single Throw	Radio	Press up to turn Power on to the Radio OFF

1850, 2050, 1880, 2080 SWITCHING

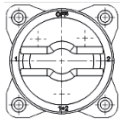

The main battery disconnect switch must be turned to the on position to provide power to the system. Turn the switch to off to remove power from the switching system and the engine.



Horn – This switch operates the horn on the boat. While pressing this button the horn will sound. Once released the horn will stop sounding.



Bilge – This switch operates the standard bilge on the boat. Pressing this button once will operate the bilge. Pressing it again will turn the bilge off.



Navigation lights – This switch operates the Navigation Lights. Pressing this switch once will turn on the red/green as well as the anchor light. Pressing this switch a second time will turn the lights off.



Anchor light – This switch operates the anchor light. With the Navigation Lights off press this switch once and the Anchor Light will come on. Pressing this switch a second time will turn the light off.



LW. Aerator – This switch operates the live well fill pump. Pressing the switch once will turn the live well fill pump on. Pressing it a second time will turn the pump off.



LW. Aerator Timed – This switch operates the timer for the live well fill pump. With the LW. FILL off, pressing this switch will activate the pump in a timed cycle of 3 minutes on and 2 minutes off. Pressing this switch a second time will turn the pump and timer off.



BW. Aerator – This switch operates the bait well fill pump. Pressing this switch once will turn the pump on. Pressing it a second time will turn the pump off.



BW. Aerator Timed – This switch operates the timer for the bait well fill pump. With the BW. Aerator switch off, pressing this switch will activate the bait well fill pump in a timed cycle of 3 minutes on and 2 minutes off. Pressing this switch a second time will turn the pump and timer off.



INT. LTS – This switch will operate any interior, bait/live well and box lights installed on the boat. Pressing this button once will turn the lights on and pressing it a second time will turn the lights off.



Radio – Pressing this switch will supply power to the radio. Pressing it a second time will turn the power off to the radio.



Trim Up – Pressing this switch will trim the engine up. Releasing this switch will stop engine trim.



Trim Down – Pressing this switch will trim the engine down. Releasing this switch will stop engine trim.

ACC – This switch operates any accessories installed on the boat. Pressing the switch once will turn the accessory on and pressing it a second time will turn the accessory off.

620FS and 621FS

Wake and Sleep Mode

Sleep mode will cause the keypad to reduce power consumption by reducing live circuits. For the keypad to enter the sleep mode it will require the main 30 amp breaker to be on, no switch activity for four hours, all pumps turned off, and the ignition is off. When the keypad is in the sleep mode the accessories will not function. To wake the keypad you must press one of the following functions: Start, Stop, 1, 2, 3, 4, or any button on the bow touch pad with the main breaker set to the on position. After pressing one of the buttons, you can then proceed with your desired operation. While the keypad is in the sleep mode, the float switch to the bilge still has power and if the float switch is triggered, it will wake the keypad. If the bilge pumps, livewell pumps or the ignition is left on, the system will not enter sleep mode.

Keyless Ignition

Starting the engine:

- Turn the main breaker to on.
- Press on the buttons required to wake the system.
- Enter the following user code unless it has not been changed in order “1-2-3-4”.
- Press “Start”. After pressing start the LED by the “1” button will light putting the keyless ignition switch in accessory mode.

- Press the “Start” button a second time holding it for two seconds and the engine will crank.
- Once the engine has started, release the “Start” button.
- To stop the engine, press the stop button.
- To lock the system after stopping the engine, enter the user code “1-2-3-4” and then press “Stop”.

To choke a carbureted engine:

Press the “Start” and the “1” key simultaneously while starting the engine.

To change the user code:

Wake the system up by pressing one of the buttons described above. Enter in the current user code followed by pressing the “1” and “4” buttons at the same time. You will have two seconds after entering in the user code to press the “1” and “4” buttons.

“1-2-3-4” → “1” and “4”

Leave the “1” and “4” depressed until the “1” LED flashes. If the “1” LED does not flash after holding the “1” and “4” down for five seconds, one of the following may have happened: the user code was not entered correctly or “1” and “4” was not depressed at the same time, or too much time elapsed after entering in the user code before pressing the “1” and “4”. Turn the system off by entering in the code and press stop. After the LED is not lit by the stop button, start at the beginning of this section again.

After the flashing of the stop LED is obtained, enter in the new four digit number followed by the start button, and then re-enter the four digit number followed by the start button.

“X-X-X-X” → “Start” → “X-X-X-X” → “Start”

After pressing the start button the second time, the system will go into accessory mode. If it does not enter accessory mode, type the current user code in and press the stop button then proceed to the beginning of this section.

Navigation Lights

The switch labeled “Nav./Anchor” on the bow and console keypads controls the operation of the navigation lights. On the first key press, the bow navigation and stern anchor lights will turn on. On the second press, the bow lights will turn off and the anchor light will remain on. On the third key press, the anchor light will turn off.

Aerator System

Pressing the “L” or “1” button will activate the rear well’s aeration pumps, pressing this button again will turn off the aeration pumps. Pressing the “B” or “2” button will activate the bait well aeration pump; pressing this button again will turn off the bait well aeration pump. At the bow pressing the aerator button once will turn on the rear well, pressing a second time will turn on the rear well and the bait well, pressing a third time will turn the pumps off. Pressing the aerator timer button will turn on the timer in the “L” setting. The timer can be adjusted in two increments “L and H”. The “L” setting is 1 minute on then 2 minutes off and “H” is 15 minutes on and 2 minutes off.

Bilge System

The switch labeled with an image of the water leaving the sump of the boat controls the bilge pumps in the boat. Pressing the button once turns on the manual bilge pump, press a second time to turn on the manual and auto bilge pump. Pressing the button a third time will turn both pumps off.

Interior Lights

Pressing the button with the light bulb activates the interior lights on the boat. Pressing this key 1 time will activate the lights; pressing the key a second time will turn off the lights. If the lights are left on, they will automatically turn off after five minutes.

Dimming the Instrument Lights and Key Pad Lights

If the boat is equipped with the standard gauges it is possible to dim the gauge lights and key pad lights for night driving. If the boat is not equipped with standard gauges the touch pad lights can be dimmed. To do so press and hold in on the light dimming button and the gauge lights along with the touch pad lights will dim down. The gauge lights will dim down to an off state. The touch pad lights will dim down 90%. Once the level of brightness is obtained, release the dimming button. The switching system will leave the lights at this brightness until the dimming switch is turned off. The indicator light around the dimming button will light showing that dimming is active. If you choose to make the lights bright again press and hold in on the dimming button until the brightness desired is obtained.

Accessories

There are five accessory functions labeled "ACC, A1, A2, and A3". The accessories buttons will drive any device up to 5 amps. Pressing the button once will turn the accessory on, and pressing a second time will turn the accessory off.

Horn

The button with the image of a trumpet is the horn button. Pressing and holding this button will sound the horn; releasing this button will turn the horn off.

O2

This button controls the oxygenator in the live well, if your boat is equipped with this option. Press this button to turn the oxygenator on, pressing it a second time will turn this item off.

Vent Fan

This button operates a blower motor used to force air from the outside into port rod, center, and the starboard storage compartments. Press this button once to turn the blower on, press it again and it will turn the blower off.

Trim

On the bow keypad, the switch with the up arrow controls the trim up and the switch with the down arrow controls the trim down. Pressing and holding the button will allow the trim to function. Releasing the button will cause the trim to stop.

Back Lighting

The back lighting will illuminate the keypad. After waking up the system, it will turn on for 60 seconds or while in the wake mode, it will turn on after any key press for 60 seconds.

Resetting a Breaker

If a circuit causes the breaker to throw it is indicated by a flashing LED. The LED corresponding to the thrown breaker will flash by its switch. If the 1 LED is the only LED flashing one of the un-switched outputs (trim, 12V, radio, auto bilge float switch, electronics, or key on engine hot) has thrown a breaker. To reset the breaker press the switch in leaving it held in for five seconds. If the light remains flashing there is a direct short present. If the light stops flashing the breaker has been reset.

Console Touch Pad Left

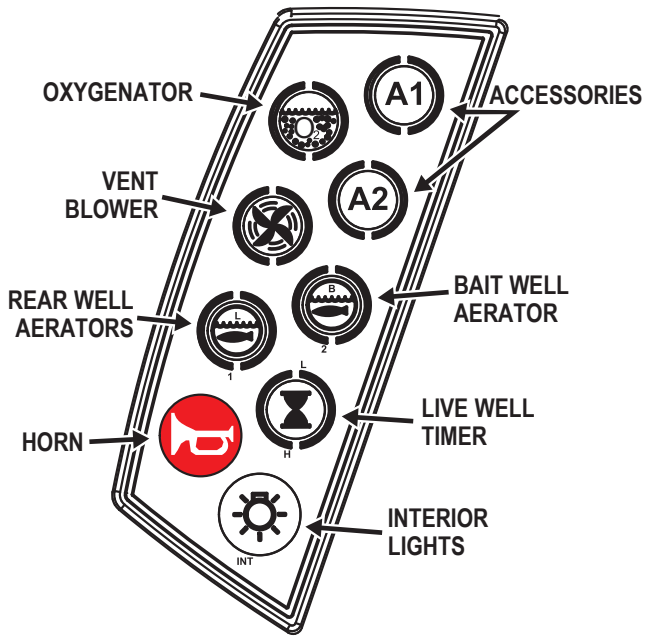

Console Touch Pad Right

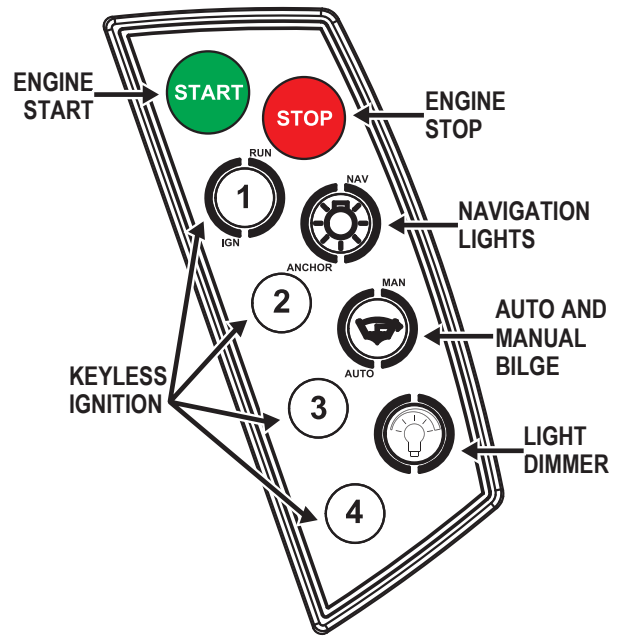

Bow Touch Pad

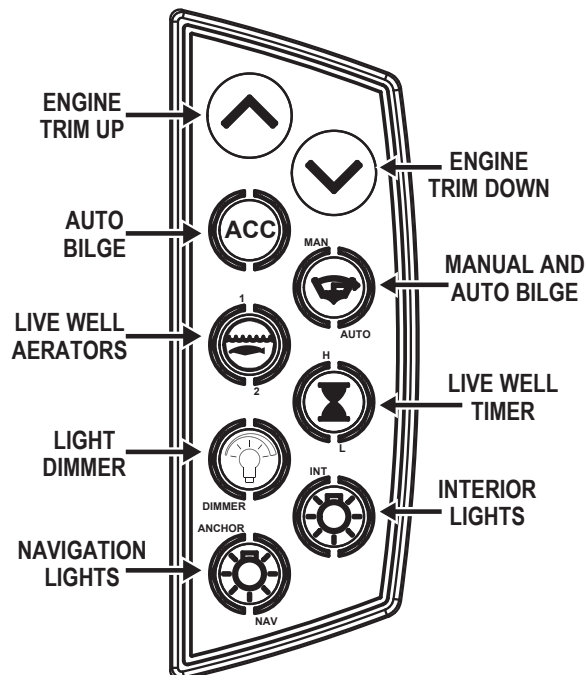

SALTWATER SERIES

Saltwater Switching

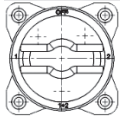

The main battery disconnect switch must be turned to battery 1 in order for the switching system to turn on. A second battery can be installed on 2. The second battery can be used for a means of boosting battery 1.



Horn – This switch operates the horn on the boat. While pressing this button the horn will sound. Once released, the horn will stop sounding.



Bilge – This switch operates the standard bilge on the boat. Pressing this button once will operate the bilge. Pressing it again will turn the bilge off.



Navigation lights – This switch operates the Navigation Lights. Pressing this switch once will turn on the red/green as well as the anchor light. Pressing this switch a second time will turn the lights off.



Anchor light – This switch operates the anchor light. With the Navigation Lights off press this switch once and the Anchor Light will come on. Pressing this switch a second time will turn the light off.



LW. Fill – This switch operates the live well fill pump. Pressing the switch once will turn the live well fill pump on. Pressing it a second time will turn the pump off.



LW. Fill Timed – This switch operates the timer for the live well fill pump. With the LW. FILL off, pressing this switch will activate the pump in a timed cycle of 3 minutes on and 2 minutes off. Pressing this switch a second time will turn the pump and timer off.

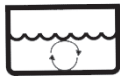

LW. Recir. – This switch turns on the recirculation pump. Pressing this switch once will turn the pump on and pressing it a second time will turn the pump off.



LW. Recir. Timed – This switch operates the timer for the live well recirculation pump. With the LW. Recir. Off pressing this switch will activate the recirculation pump in a timed cycle of 3 minutes on and 2 minutes off. Pressing this switch a second time will turn the pump and timer off.



BW. Aerator – This switch operates the bait well fill pump. Pressing this switch once will turn the pump on. Pressing it a second time will turn the pump off.



BW. Aerator Timed – This switch operates the timer for the bait well fill pump. With the BW. Aerator switch off, pressing this switch will activate the bait well fill pump in a timed cycle of 3 minutes on and 2 minutes off. Pressing this switch a second time will turn the pump and timer off.



INT. LTS – This switch will operate any interior, bait/live well and box lights installed on the boat. Pressing this button once will turn the lights on and pressing it a second time will turn the lights off.

ACC – This switch operates any accessories installed on the boat. Pressing the switch once will turn the accessory on and pressing it a second time will turn the accessory off. Our standard setup: the optional bilge is installed on ACC 1, raw water wash down is installed on ACC 2, optional aerator is installed on ACC 3, and the fresh water wash down is installed on ACC 4.

**SALTWATER SERIES
2360/2350/2510 BAY**

On the console switch panel, switches from left to right: Horn, Navigational/Anchor Lights (up displays all navigational lights, center off, down displays anchor light only), Bilge Pump #1, Bilge Pump #2, Interior Lights, Underwater Lights, Rod Compartment Ventilation Fans, Accessory Switch, Raw Water Wash-down, Fresh Water Wash-down. (If supplied with T-Top; Front Spreader Light, Rear Spreader Light, Overhead Lights), 12 Volt Plug rated at 10 Amps. Above switches are circuit breakers for the switch below them. If circuit is overloaded, the breaker will pop out and have to be pushed in to reset.



Switch panel on Leaning Post left to right: Aerator Fill 1, Aerator Fill 2, Recirculate Pump, Live well Light, Battery Selector Switch. When using the Leaning Post Bait Well, it is not necessary to use both pumps as the bait well could overflow, Two pumps was added standard, so if one malfunctioned, you could have another one as backup. The recirculate pump recirculates the water in the bait well. It can be used when the boat is on trailer or for any other reason. The live well light lights the inside of the bait well.

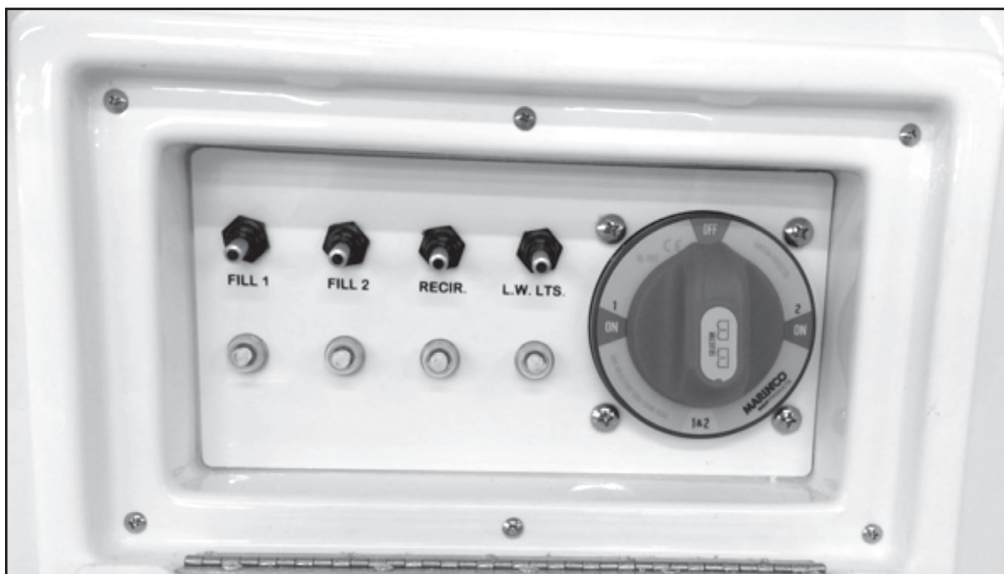

Battery Switch:

OFF position when boat is in storage and/or charging batteries (turn switch to this position before connecting battery charger to 110V supply. The handle can be removed for additional security in this position.

- 1 (ON) Switch position while boat is in use (This is the “house battery” for engine and all boat, except trolling motor). Use this position in normal conditions.
- 2 (ON) position connects to one trolling motor battery only.
- 1 + 2 position combines the crank and trolling motor battery in case extra starting power is needed.

Refer to schematic on battery compartment door for additional details.



The two switches inside the console controls the overhead light and ventilation fan for the console. There may be additional inline fuses in this area for optional electronics.

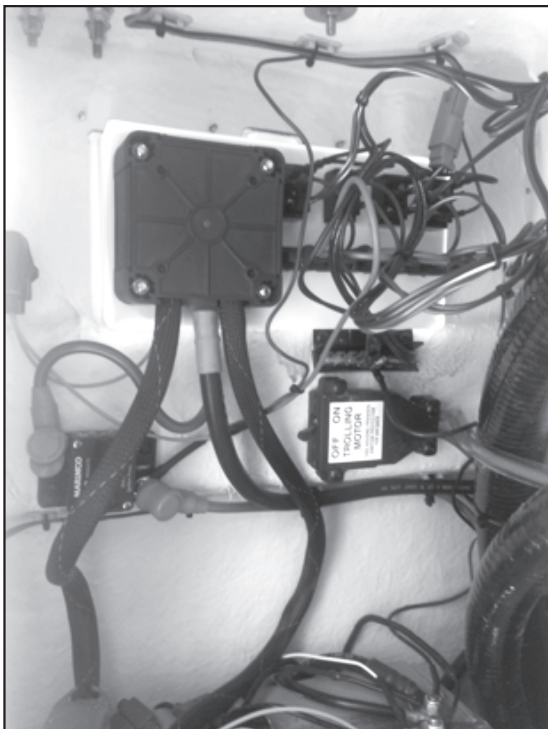

Inside the Leaning Post on the starboard side above the crank battery, you will find the 30 Amp Main Circuit Breaker, 50 Amp Trolling Motor Circuit Breaker, and 10 Amp Inline Fuse for Auto Bilge Pump. Additional Circuit Breakers/Inline Fuses may also be in this vicinity or the batteries for optional equipment. (Chargers has inline fuses on each lead going to the positive and negative posts). There may also be optional, (such as power pole anchors) Circuit Breakers/Inline Fuses under the rear seating in the vicinity of the double insulated studs that extend the engine leads to the leaning post.

Z520c, Z521c

Wake and Sleep Mode

Sleep mode will cause the key pad to reduce power consumption by reducing live circuits. For the key pad to enter the sleep mode it will require the main 30 amp breaker to be on and no switch activity for four hours, all pumps turned off, and the ignition is off. When the key pad is in the sleep mode the accessories will not function. To wake the key pad you must press one of the following functions: Start, Stop, 1, 2, 3, 4, or any button on the bow touch pad with the main breaker set to the on position. After pressing one of the buttons you can then proceed with your desired operation. While the key pad is in the sleep mode the float switch to the bilge still has power and if the float switch is triggered it will wake the key pad. If the bilge pumps, live well pumps, or ignition is left on, the system will not enter sleep mode.

Keyless Ignition

Starting the engine:

- Turn the main breaker to on.
- Press on the buttons required to wake the system.
- Enter the following user code unless it has not been changed in order “1-2-3-4”.
- Press “Start”. After pressing start the LED by the 1 button will light putting the keyless ignition switch in accessory mode.
- Press the “Start” button a second time holding it for two seconds and the engine will crank.
- Once the engine has started, release the “Start” button.
- To stop the engine, press the stop button.
- To lock the system after stopping the engine, enter the user code “1-2-3-4” and then press “Stop”.

To choke a carbureted engine:

Press the “Start” and the “1” key simultaneously while starting the engine.

To change the user code:

Wake the system up by pressing one of the buttons described above. Enter in the current user code followed by pressing the “1” and “4” buttons at the same time. You will have 2 seconds after entering in the user code to press the “1” and “4” buttons.

“1-2-3-4” → “1&4”

Leave the “1&4” depressed until the 1 LED flashes. If the 1 LED does not flash after holding the “1&4” down for 5 seconds, one of the following may have happened: the user code was not entered correctly, or 1 and 4 were not depressed at the same time, or too much time elapsed after entering in the user code before pressing the 1 and 4. Turn the system off by entering in the code and press stop. After the LED is not lit by the stop button, start at the beginning of this section again.

After the flashing of the stop LED is obtained, enter in the new four digit number followed by the start button, and then re-enter the four digit number followed by the start button.

“X-X-X-X” → “Start” → “X-X-X-X” → “Start”

After pressing the start button the second time the system will go into accessory mode. If it does not enter accessory mode, type the current user code in and press the stop button, then proceed at the beginning of this section.

Navigation Lights

The switch labeled “Nav./Anchor” on the bow and console keypads controls the operation of the navigation lights. On the first key press, the bow navigation and stern anchor lights will turn on. On the second press the bow lights will turn off and the anchor light will remain on. On the third key press the anchor light will turn off.

Aerator System

Pressing the live well key will activate two aeration pumps. Pressing this button again will turn off the aeration pumps. Pressing the live well timer button will automatically turn on the aeration pumps and the timer in the “L” setting. The timer can be adjusted in two increments, “L and H”. The “L” setting is 1 minute on and 2 minutes off and “H” is 15 minutes on and 2 minutes off.

Bilge System

The switch labeled with an image of the water leaving the sump of the boat controls the bilge pumps in the boat. Pressing the button once turns on the manual bilge pump, press a second time to turn on the manual and auto bilge pump. Pressing the button a third time will turn both pumps off.

Interior Lights

Pressing the button with the light bulb activates the interior lights on the boat. Pressing this key 1 time will activate the lights. Pressing the key a second time will turn off the lights. If the lights are left on they will automatically turn off after five minutes.

Dimming the Instrument Lights and Key pad Lights

If the boat is equipped with the standard gauges it is possible to dim the gauge lights and key pad lights for night driving. If the boat is not equipped with standard gauges the touch pad lights can be dimmed. To do so press and hold in on the light dimming button and the gauge lights along with the touch pad lights will dim down. The gauge lights will dim down to an off state. The touch pad lights will dim down 90%. Once the level of brightness is obtained, release the dimming button. The switching system will leave the lights at this brightness until the dimming switch is turned off. The indicator light around the dimming button will light showing that dimming is active. If you choose to make the lights bright again press and hold in on the dimming button until the brightness desired is obtained.

Accessories

There are five accessory functions labeled “ACC, A1, A2, and A3”. The accessories buttons will drive any device up to 5 amps. Pressing the button once will turn the accessory on. Pressing a second time will turn the accessory off.

Horn

The button with the image of a trumpet is the horn button. Pressing and holding this button will sound the horn; releasing this button will turn the horn off.

O2

This button controls the oxygenator in the live well, if your boat is equipped with this option. Press this button to turn the oxygenator on, and pressing it a second time will turn this item off.

Vent Fan

This button operates a blower motor used to force air from the outside into port rod, center, and the starboard storage compartments. Press this button once to turn the blower on. Press it again and it will turn the blower off.

Trim

On the bow keypad, the switch with the up arrow controls the trim up and the switch with the down arrow controls the trim down. Pressing and holding the button will allow the trim to function. Releasing the button will cause the trim to stop.

Back Lighting

The back lighting will illuminate the key pad. After waking up the system it will turn on for 60 seconds or while in the wake mode it will turn on after any key press for 60 seconds.

Resetting a Breaker

If a circuit causes the breaker to throw it is indicated by a flashing LED. The LED corresponding to the thrown breaker will flash by its switch. If the 1 LED is the only LED flashing one of the un-switched outputs (trim, 12V, radio, auto bilge float switch, electronics, or key on engine hot) has thrown a breaker. To reset the breaker press the switch in, leaving it held in for five seconds. If the light remains flashing there is a direct short present. If the light stops flashing the breaker has been reset.

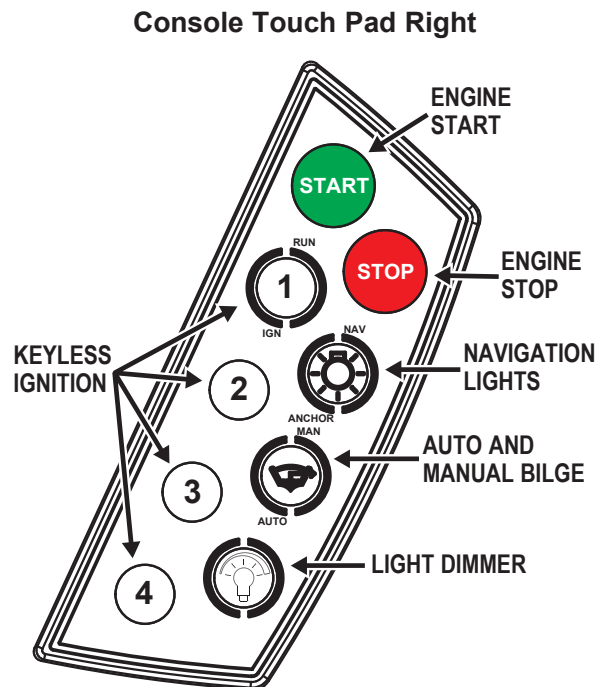
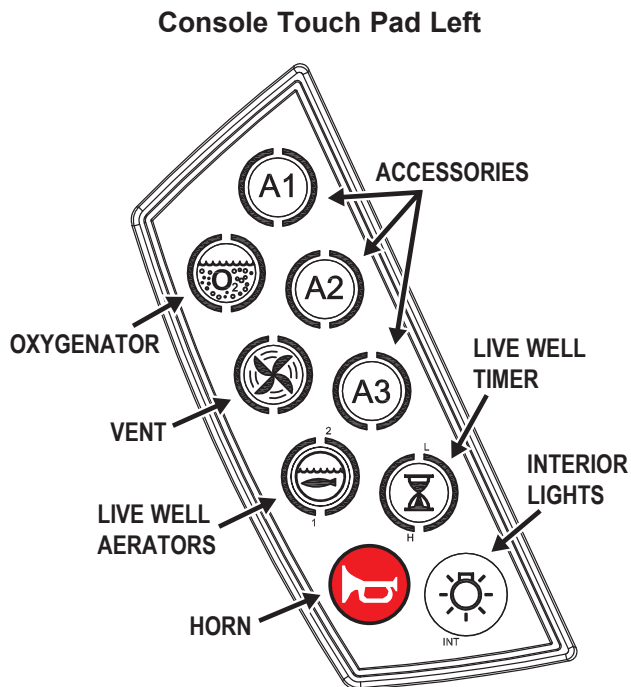

Bow Touch Pad

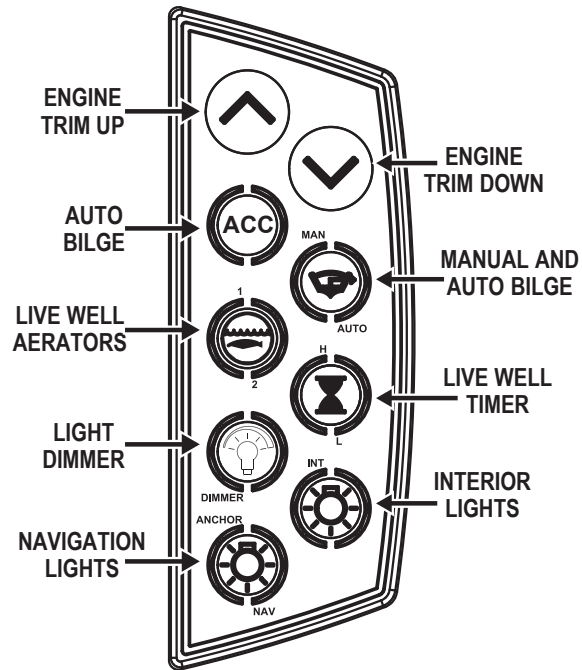

Z518L, Z519L, Z520L, Z521L

Wake and Sleep Mode

Sleep mode will cause the keypad to reduce power consumption by reducing live circuits. For the keypad to enter sleep mode, it will require the main 30 amp breaker to be on and no switch activity for four hours, all pumps turned off, and the ignition off. While the keypad is in the sleep mode, the accessories will not function. To wake the keypad, you must press one of the following functions: “Start”, “Stop”, “1”, “2”, “3”, “4”, or any button on the bow touch pad with the main breaker set to the “ON” position. After pressing one of these buttons, you can then proceed with your desired operation. While the keypad is in sleep mode, the float switch to the bilge still has power and if the float switch is triggered, it will wake the keypad. If any bilge pump, livewell pump, or ignition is left on, the system will not enter sleep mode.

Keyless Ignition

Starting the engine:

- Turn the main breaker to “ON”.
- Press the buttons required to wake the system.
- Enter the following user code, unless it has been changed, in order “1-2-3-4”.
- Press “Start”. After pressing start, the LED by the “Stop” button will illuminate, putting the keyless ignition switch into accessory mode.
- Press the “Start” button a second time, holding it for two seconds, and the engine will crank.
- Once the engine has started, release the “Start” button.
- To stop the engine, press the “Stop” button once.
- To lock the system after stopping the engine, enter the user code “1-2-3-4” and then press “Stop”.

While the engine is cranking there will be some functions that will momentarily shut off. These functions are the Livewell pumps, Interior Lights, Compartment Fan, and Accessory switches.

To change the user code:

Wake the system by pressing one of the buttons described above. Enter in the current user code, followed by pressing the “1” and “4” buttons at the same time. You will have 2 seconds after entering in the user code to press the “1” and “4” buttons.

“1-2-3-4” → “1&4”

Leave the “1” and “4” buttons depressed until the “Start” LED flashes. If the “Start” LED does not flash after holding the “1” and “4” down for 5 seconds, one of the following may have happened: (1) the user code was not entered correctly, or (2) “1” and “4” were not depressed at the same time, or (3) too much time elapsed after entering in the user code before pressing the “1” and “4” buttons. Turn the system off by entering in the code and press “Stop”. Once the LED by the “Start” button is no longer lit, start at the beginning of this section again.

After the flashing of the “Start” LED is obtained, enter in the new four digit number followed by the “Start” button, and then re-enter the four digit number followed by the “Start” button again.

“X-X-X-X” → “Start” → “X-X-X-X” → “Start”

After pressing the “Start” button the second time, the system will go into accessory mode. If it does not enter accessory mode, re-enter the current user code in and press the “Start” button, then proceed at the beginning of this section.

Indicator Lights

Each button has an indicator light next to it. The indicator light will inform you if the device being controlled by the button is on or off. If the device is on, the indicator light will illuminate blue. If the device is off, the indicator light will be white. The Indicator light will also flash if the circuit has an issue. This is covered in the “Resetting a Breaker” section.

Navigation Lights

The switch labeled “Navigation/Anchor” on the bow and console keypads controls the operation of the navigation lights. On the first key press the bow navigation and stern anchor lights will turn on. On the second press the bow lights will turn off and the anchor light will remain on. On the third key press the anchor light will turn off. The Navigation Lights circuit is rated for 6 amps.

Aerator System

Pressing the livewell key will activate two aeration pumps, pressing this button again will turn off the aeration pumps. Pressing the livewell timer button will automatically turn on the aeration pumps and the timer in the “L” setting. The timer can be adjusted in three increments “L, M, and H”. The “L” setting is 1 minute on and 2 minutes off, “M” is 5 minutes on and 1 minute off, “H” is 15 minutes on and 2 minutes off. The aeration system has two pumps. Each pump is rated at 6 amps each.

Oxygenator Button

The oxygenator button controls a device that will add oxygen to the livewell. Pressing this button once will turn on the device and pressing a second time will turn it off. This circuit is rated at 3 amps.

Compartment Fan PVRS

Pressing this button once will turn on the compartment fan (PVRS) system, pressing it a second time will turn the fan off. This PVRS system will run until power is removed. The PVRS circuit is rated at 6 amps.

Bilge System

There are two buttons for bilge pumps. One button is for the manual bilge pump and the other is the override for the auto bilge. Pressing the button once will activate the pump, pressing the button a second time will turn the pump off. Manual bilge is rated for 6 amps and the auto bilge is rated for 5 amps.

Interior Lights

Pressing the button with the light bulb activates the interior lights on the boat. Pressing this button one time will activate the lights, pressing the button a second time will turn off the lights. If navigation lights are turned on while the interior lights are on, some of the interior lights will turn off. The interior light circuit is rated at 6 amps.

Dimming the Instrument Lights and Key Pad Lights

If the boat is equipped with the standard gauges, it is possible to dim the gauge lights and key pad lights for night driving. There is a button marked for dimming the lights. Pressing this button and holding it in will cause the lights to dim. Once the level of brightness is achieved release the button. Pressing the dimming button a second time will turn the dimming function off and the lights will return to full brightness.

Accessories

There are five accessory functions labeled “ACC, A1, A2, A3 and A4”. All other accessories buttons will drive any device up to 6 amps. Pressing the button once will turn the accessory on; pressing a second time will turn the accessory off. Each accessory is rated for 6 amps.

Horn

The button with the image of a trumpet is the horn button. Pressing and holding this button will sound the horn, releasing this button will turn the horn off. The horn is rated at 7.5 amps.

Trim

On the bow keypad, the switch with the up arrow controls the trim up and the switch with the down arrow controls the trim down. Pressing and holding the button will allow the trim to function; releasing the button will cause the trim to stop. Trim is rated at 10 amps.

Back Lighting

The back lighting will illuminate the key pad, after waking up the system it will turn on for 60 seconds or while in the wake mode it will turn on after any key press for 60 seconds.

Radio

The Radio will gain power once the keyless has the Unlock light lit. The Radio circuit is rated for 10 amps.

Reset a Breaker

If a circuit causes the breaker to throw it is indicated by a flashing LED. The LED corresponding to the thrown breaker will flash by its switch along with the stop LED. If the stop LED is the only LED flashing one of the un-switched outputs (trim, 12V, radio, auto bilge float switch, electronics, or key on engine hot) has thrown a breaker. To reset the breaker press the switch leaving it held in for five seconds. If the light remains flashing, there is a direct short present. If the light stops flashing the breaker has been reset.

There are some items on the boat that are not switched by the touch pads. The L series boat would include items such as the 12 Volt Receptacle, USB, Radio, Bow Non-switched Accessory Hot and Gauge Lights. Because of this the Unlocked LED will flash a specific number of times for each instance. The flash rate will be short flashes at ½ second; it will be separated by a single long flash of 2 seconds. If one of these items is creating a trip breaker. To reset it you will need to press and hold in on the Stop button.

FLASH COUNT	FAULTED OUTPUT
1	Gauge Lights
2	Radio
3	12 Volt Receptacle/USB
4	Bow Non-switched Accessory

Keyless Ignition Touch Pad

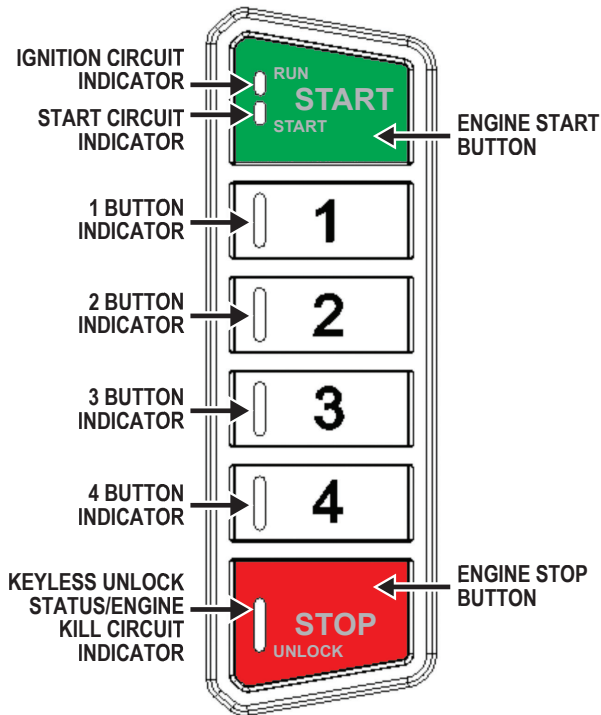

Console Accessories Touch Pad

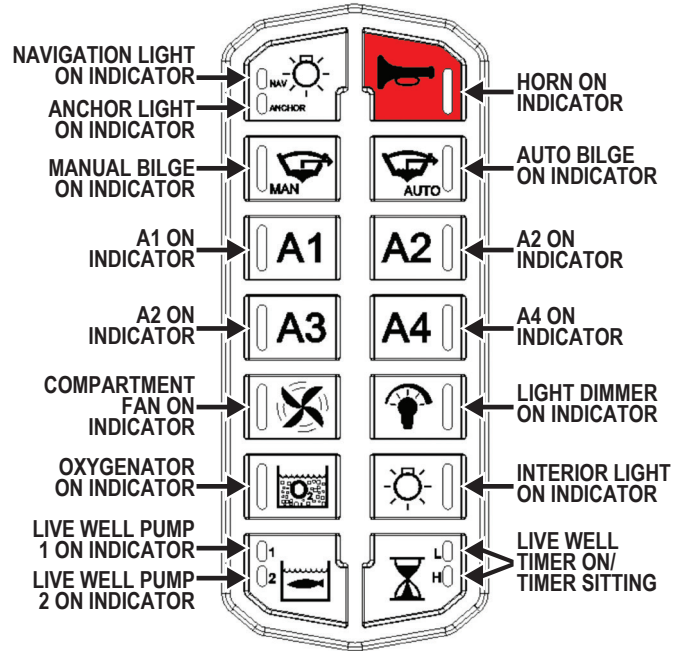

Bow Touch Pad

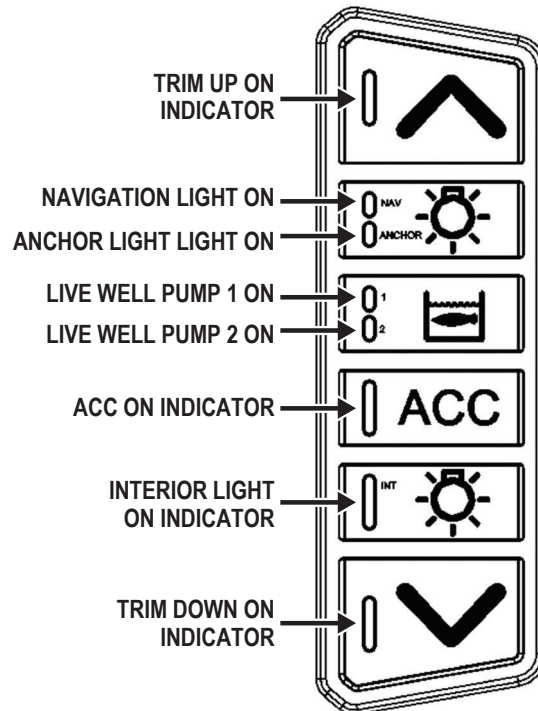

SAFETY AND MAINTENANCE TIPS

- Check battery connections periodically to make sure they are corrosion free and TIGHT.
- Be sure battery switch is in OFF position when storing boat.
- Be sure battery switch is in OFF position when charging batteries.
- Alteration of any part of the wiring system should be avoided! Such alterations could cause damage and/or electrical short.
- Inspect wiring connections and terminals periodically for damage, corrosion, etc. and replace as needed. Replacement should always be of equal or greater rating and quality. We recommend Ranger replacement parts available through your Ranger dealer.
- Always disconnect the positive and negative leads from the battery terminals before installing, removing, servicing, or troubleshooting any part of the electrical system.



WARNING

Batteries produce hydrogen and oxygen gases when charging. These explosive gases escape through the vent/fill caps and may form an explosive atmosphere around the battery if the ventilation is poor. This gas may remain around the battery for several hours after charging is completed. Sparks or open flames can ignite the gas and cause an explosion.



WARNING

Sulfuric acid in batteries can cause severe burns. Avoid contact with skin, eyes, or clothing. Wear goggles, rubber gloves and a protective apron when working with batteries.

FEDERAL REQUIREMENTS FOR RECREATIONAL BOATS

Boat operators are required to file a boating accident report when their boat is involved in certain boating accidents as follows:

Damage to property that exceeds \$500. Federal law requires the operator – or owner, if the operator is deceased or unable to make the report – to file a boating accident report with the State reporting authority when, as a result of an occurrence that involves a boat or its equipment:

- A person dies
- A person disappears from the vessel under circumstances that indicate death or injury
- A person is injured and requires medical treatment beyond first aid
- Damage to vessels and other property totals \$2,000 (lower amounts in some states and territories) or more
- Go to www.uscgboating.org to download the online accident forms.

Boating Safety Checklist

MUST HAVE ITEMS

As Required By Regulation

Personal Flotation Devices (Life Jackets)

- Type I, II, III, or V for each person onboard (wearable)
- One Type IV (Throwable)*

*Not Required on Non-Powered boats under 16'

Fire Extinguishers

Choose One	Boats without Fixed System	-OR-	Boats with Fixed System
<input type="checkbox"/> Boats <26'	1 Size BI	-OR-	Fixed System
<input type="checkbox"/> Boats 26 -<40'	2 Size BI*	-OR-	Fixed System + 1 Size BI
<input type="checkbox"/> Boats 40 - 65'	3 Size BI*	-OR-	Fixed System + 2 Size BI*

*One Size BI may be substituted for Two Size BI Extinguishers

Visual Distress Signals (VDS)

Choose One

- Combination Day/Night VDS (Flares or Flare Gun)
- Daytime VDS (Flags, Smoke Signal)
AND Nighttime VDS (Automated SOS Light)

Sound Signals

- Horn or Whistle
- Bell (Not required for vessels under 12m)

Ventilation (Boats with Gasoline Systems)

- Natural Ventilation
- Powered Ventilation

Backfire Flame Control

- Backfire Flame Arrestor (Gasoline Engines except outboards)

- The above represents minimum USCG Safety Requirements on-board vessels.
- Other Requirements may be necessary to comply with state laws.
- This is not intended to be an all-inclusive list but rather a baseline of items to make your boating adventure safe and fun.
- For Vessels over 65' refer to 33CFR 25.30-20 or ABYC A-4.



RECOMMENDED ITEMS

Items in Red May be Required in Some States

Boats on Inland Waters

Everything on Required List PLUS:

- First Aid Kit
- Anchor with Sufficient Line
- Boating Safety Education/Certificate
- Watersports Flag (Skier Down/Diver Down Flag)
- Bailing Device
- Sun Protection
- Alternate Propulsion (Paddles, Oars)

Boats on Nearshore Waters

Everything Above PLUS:

- Extra Food & Water
- Depth Finder
- VHF Radio
- GPS/Chartplotter
- Compass
- Spare Tool Kit
- Float Plan
- Charts

Boats on Offshore Waters

Everything Above PLUS:

- EPIRB
- Life Raft
- Searchlight
- List of CPR Instruction
- Radar
- Radar Reflector
- Radio Direction Finder
- Man-Overboard Recovery Gear
- AIS
- Sea Drogue
- Safety Knife
- Weather Information System
- Shore Landing Craft (Tender)
- Long Range Communications Gear

Boats on River Waters

Everything on Required List Plus:

- Throw Bag
- Helmet

Miscellaneous Items

Other Items That May be Recommended:

- Heaving Line
- Spare Keys
- Boat Hook/Pole
- Spare Propeller
- Extra Engine Oil
- Handheld Lead-line
- Strobe Light
- Carbon Monoxide Detector
- Extra Clothing
- Marine Hardware
- Masks & Fins (For Clearing Props)
- Storm Sails

Federal Requirements for Recreational Boats

EQUIPMENT	CLASS A (Under 16' in Length)	CLASS I (16', but under 26')
Whistle or Horn	Must have means of making an efficient sound signal.	
Visual Distress	None Required During Daytime	All recreational boats, when used on coastal waters, which includes the Great Lakes, the Territorial Seas, and those Waters directly connected to the Great Lakes and the Territorial Seas, up to a point where the waters are less than two miles wide, must be equipped with visual distress signals.
Inland and International Rules Navigational Lights	Proper light displays are required to be shown from sunset to sunrise.	
Fire Extinguishers	One B-1 U.S.C.G. or U.L. approved fire extinguisher unless the construction is such that explosive flammable vapors cannot be trapped, there are no closed compartments, no permanently installed fuel tanks on board.	
PFDS	Type I, II, III, or V for each person aboard.	Type I, II, III, or V for each person aboard and one Type IV.
Numbering	All undocumented vessels equipped with propulsion machinery must be numbered in the state of principal use.	
Certificate of Number	A valid certificate of number showing the numbers issued to a vessel must be on board whenever the vessel is in use.	
Display of Number	Number must be painted or permanently attached to each of the forward halves of the vessel, and no other number may be displayed thereon.	

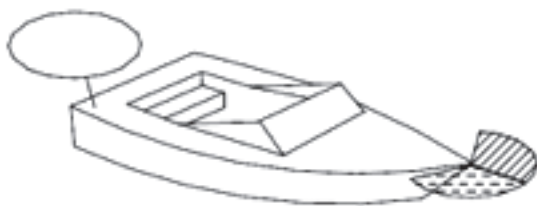

3A INTERNATIONAL OR INLAND

3B FOR INLAND ONLY



NOTE: The above information is not conclusive. The owner/operator should check all current Federal, State, and Local Regulations to ensure compliance.

GENERAL INFORMATION AND MAINTENANCE

- Check all lights before each use of the trailer.
- Check the tires for wear, cuts or other damage before each use and replace as needed. Check tire pressure often. See tire sidewall for maximum pressure and maximum load.
- Check lug nuts for tightness before use. Torque lug nuts to 95-100 ft. lbs.
- Periodically check the winch strap and winch parts for any wear and replace worn parts.
- Remember... a small expense for preventive maintenance is much less expensive now than a road-side breakdown later!

Steps for Determining Correct Load Limit



CAUTION

Trailer tires should be properly inflated and maintained! The load-carrying capacity of your trailer is based on the tire pressure. Inadequate tire pressures can void your tire and trailer warranty and could also lead to an accident damaging to people or equipment!



WARNING

Lug nuts should be properly tightened before each use. Failure to do so could result in loss of a wheel and could lead to an accident causing injury or death.

CONTAINED OIL ORBITAL LUBRICATION (COOL) HUBS

Ranger Trail COOL hubs have a 3 year “No Touch” warranty. There is no required maintenance for three years from the original date of purchase. If for some unforeseen reason the hub develops an actual leak, it will be replaced under our limited warranty. It is normal for Hybrid Oil filled hubs to weep out small amounts of lubricant at the rear seal. When this happens, the oil will collect dirt and fall off onto the wheels as black spots. This is not a leak. Soap and water will remove this and clean your wheels. A Hybrid Oil leak will leave a film on the wheel that you will be able to see.

REPORTING SAFETY DEFECTS

If you believe that your vehicle has a defect which could cause a crash or could cause injury or death, you should immediately inform the National Highway Traffic Safety Administration (NHTSA) in addition to notifying Ranger Boats.

If NHTSA receives similar complaints, it may open an investigation, and if it finds that a safety defect exists in a group of vehicles, it may order a recall and remedy campaign. However, NHTSA cannot become involved in individual problems between you, your dealer, or Ranger Boats.

To contact NHTSA, you may call the Vehicle Safety Hotline toll-free at 1-888-327-4236 (TTY: 1-800-424-9153); go to <http://nhtsa.safercar.gov>; or write to: Administrator, NHTSA, 1200 New Jersey Avenue SE, Washington, DC 20590. You can also obtain other information about motor vehicle safety from <http://www.safercar.gov>.

TRAILER BRAKES

If your trailer is equipped with brakes, follow the safety and maintenance tips listed below for best service.

- Always hook up the brake breakaway cable securely to the tow vehicle (should the trailer come loose, cable will activate the brakes to help slow runaway trailer). Before towing, make sure that the emergency breakaway cable has not been inadvertently set. Reset to normal position by pushing the lever up. This will release the E-stop cable (see Fig. 6 on how to reset if indicator bead is exposed). **Always insert hitch pin after latching coupler to trailer ball.**
- Disc brake trailers are equipped with an electric solenoid valve to prevent the disc brakes from being activated while reversing your trailer. Disc brakes will operate at full capacity in either direction. It is therefore essential that the wire from the solenoid valve be connected to the reverse light wire of the tow vehicle. When the tow vehicle is put in reverse gear, the solenoid will deactivate the brakes and allow you to back up.

To check proper operation of solenoid valve, place tow vehicle gear shift in reverse (with engine shut off and ignition on). Backup lights should turn on and an audible “click” should be heard at the valve. If lights come on and no “click” is heard, check for an electrical wiring or connection problem. The reverse solenoid is located on the rear of the master cylinder.

- Check plug under cap to be sure it is seated fully.
- Follow routine maintenance and inspection for disc brakes as outlined in your Disc Brake Manual.



CAUTION

Make sure back up lights **do not** come on when tow vehicle transmission is in any gear other than reverse.

To minimize corrosion, it is necessary for the disc brake calipers and rotors to be rinsed off with fresh water after trailer has been immersed in saltwater.



CAUTION

Saltwater model trailers, although designed for the saltwater environment, require specific cleaning and wash-down after each use. Failure to do so could cause excessive corrosion to accumulate that could lead to trailer damage or part failure. Also, the trailer wheels should be removed once per year to clean the hub face and wheel studs, as corrosion buildup on the wheels, studs and lug nuts will make them difficult to remove. Corrosion damage caused by lack of maintenance would not be covered under the limited warranty. Please contact your Ranger dealer for proper trailer cleaning procedures.

INSPECTION

To assure continued proper operation of our trailer disc brakes, annual inspection is recommended.

FIG. 6

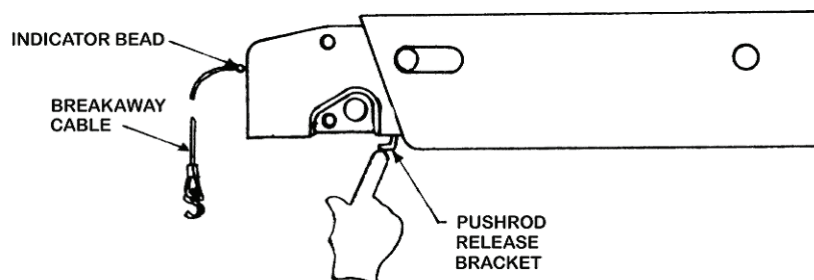
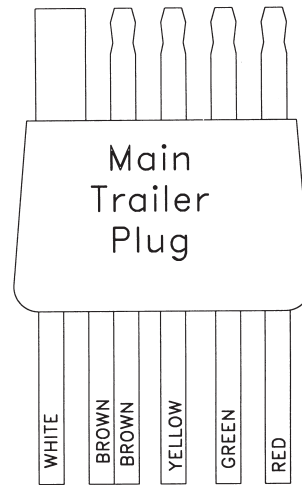

FIG. 7 RANGERTRAIL WIRING

WHITE – Ground
BROWN – Tail & Clearance lights
YELLOW – Left stop & turn lights
GREEN – Right stop & turn lights
Red – To back-up light wire on vehicle



PADS

Pads must be replaced when 1/16 inch (0.060”) of pad friction material is left.



CAUTION

If not familiar with disc brake pad replacement, have work performed by a qualified individual or service shop.

ROTORS

Rotors should be resurfaced by a qualified brake specialist if extreme galling or wear marks are present.



CAUTION

Rotors must be replaced if distance between brake surfaces becomes less than 0.670 inches (17.0 mm) due to wear or machining.

RUST

Check for extreme rust on mounting bolts, flanges and welds, which may weaken the structural integrity of the system. Repair or replace as necessary.

LEAKS



CAUTION

Check for leaks in the brake lines and fittings. Leaks will lead to loss of trailer braking ability. Repair or replace as necessary.

REPLACEMENT PARTS

For questions and parts ordering, please contact: UFP, 135 Sunshine Lane, San Marcos, CA 92069, 800-854-1905. For warranty, please contact: UFP, 1041 Baxter Lane, Winchester, TN 37398, 800-835-9211 extension 16.



WARNING

The braking mechanism on this trailer is designed as an aid in slowing and stopping the trailer. The braking system on the tow vehicle is the primary slowing and stopping system. You will not be able to stop the tow vehicle and the towed trailer as quickly as you could stop the tow vehicle alone.

NEVER TOW YOUR TRAILER WITHOUT THE LOCK PIN INSTALLED!

BEFORE TOWING YOUR RANGERTRAIL® TRAILER . . .

Make sure that your tow vehicle is equipped with a **2-inch ball** of machined or forged steel! **Never** use a ball smaller than 1.97 inch diameter or larger than 2.0 inch diameter. Naturally, your tow vehicle should be equipped with a properly rated and substantial towing hitch, well braced and firmly connected to your vehicle. Make sure that your vehicle is properly wired for the trailer light connection.

The height of the towing ball above the ground will greatly influence the tongue weight and the towing characteristics of the trailer. With the trailer attached to the tow vehicle, the top of the swing tongue should be 20" to 22" from the ground.

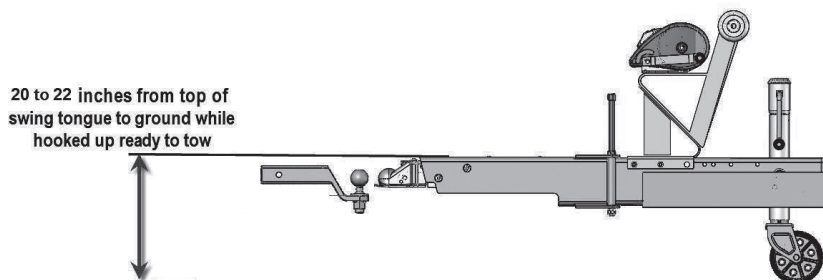

TOWING YOUR RANGER TRAIL® TRAILER . . .

Back your tow vehicle into position so that the ball is directly under the trailer hitch ball socket. Stop your vehicle's engine and set parking brake. Make sure that the release handle on the trailer hitch is raised and pulled to the rear. This will show that the ball socket is open and ready to receive the tow ball. Then, by turning the tongue jack handle, lower the hitch until it seats fully on the tow ball. Be sure that the tongue jack wheel is slightly clear of the ground. Close the ball socket latch by pushing downward into the recess. The release handle should close smoothly if the ball has been seated correctly into the socket. If the release handle does not close, **DO NOT TOW THE TRAILER**. Insert safety pin through hole. To make sure that the connection is secure, lower the tongue jack until the ram has lifted the trailer hitch and trailer tongue connection 3 or 4 inches. If the ball does not disengage, you may be reasonably sure that the attachment is secure.



NOTICE

Aluminum wheels require careful wash down maintenance and are not warranted against surface corrosion.

Next, fully retract the jack into the full up position and latch. Connect the safety cables to the connection points on your tow vehicle hitch.

If your trailer is equipped with brakes, hook up the emergency breakaway cable and inspect to see that the breakaway cable button stop is not showing. Please refer to your brake owners manual. For questions and parts ordering, please contact: UFP, 135 Sunshine Lane, San Marcos, CA 92069, 800-854-1905; for warranty, please contact: UFP, 1041 Baxter Lane, Winchester, TN 37398, 800-835-9211 extension 16.

On swing hitch trailers, make sure the hitch is in the forward position and the locking pin is properly installed. Connect your trailer wire harness and test your vehicle lights to make sure that the trailer's brake and turn signals duplicate your vehicle's. Remove any trailer wheel chock and carefully pull away.

To unhitch your trailer from the tow vehicle, place the trailer on a level and paved surface and chock both trailer wheels to prevent any movement forward or backward. Unhook the safety cables, wiring harness and, if so equipped, the brake break-away cable. Then, using the trailer tongue jack, raise the hitch up and clear the ball. In this position the trailer tongue should be left somewhat bow high so that any water will run out through the drain hole in the stern of the boat.

All Ranger Trail trailers that have a GVWR of more than 5000 lbs. must use a Class IV hitch and 6000 lb. 2-inch trailer ball.

⚠ CAUTION	Retract jack fully before towing! Replace coupler and ball if worn... do not attempt repair or adjustment.
------------------	--

HITCH CLASS RATING	MID-SIZE CARS	FULL-SIZE CARS MINI-TRUCKS & VANS	FULL-SIZE TRUCKS VANS & SUV'S
Class II WC GTW - Up to 3,500 lbs WC TW - up to 350 lbs.	Medium Duty	Medium Duty	Medium Duty
Class III WC GTW - Up to 5,000 lbs WC TW - up to 500 lbs.		Heavy Duty	Heavy Duty
Class IV WC GTW - Up to 7,500 lbs. WC TW - up to 750 lbs WD GTW - Up to 12,000 lbs. WD TW - Up to 1,200 lbs.		Heavy Duty	Heavy Duty

Very important to keep the winch tight with keel in contact with the bow roller. (Bow eye normally does not touch the bow roller.)

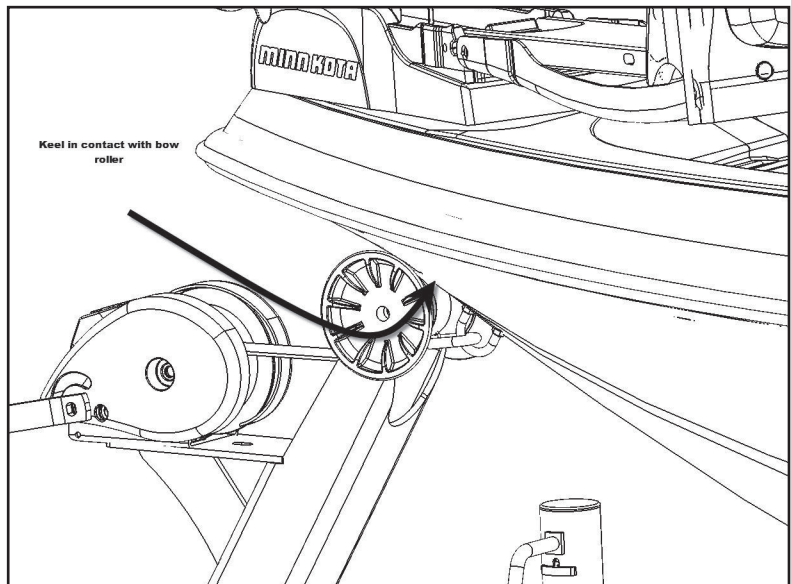

INFORMATION CONTAINED ON THE SIDEWALL OF THE TIRE

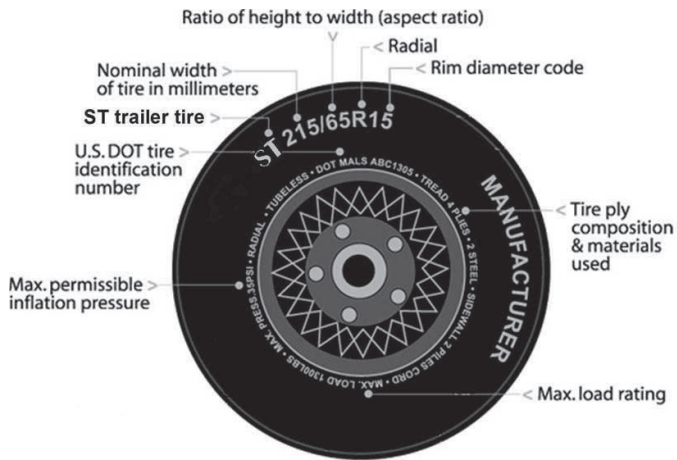

Both U.S. and Canada Federal regulations require tire manufacturers to place standardized information on the sidewall of all tires. This information identifies and describes the characteristics of the tire.

Maximum Permissible Inflation Pressure: Indicates the tire manufacturer's maximum permissible pressure and/or the pressure at which the maximum load can be carried by the tire. Refer to the Certification Label on the port forward half of the trailer for the correct tire pressure for your trailer.

U.S. DOT Tire Identification Number (TIN)

This begins with the letters 'DOT' and indicates the tire meets all federal standards. The next two numbers or letters are the plant code designating where it was manufactured, the next two are the tire size code, and the last four numbers represent the week and year the tire was built. For example, the numbers 5110 mean the tire was built the 51st week of 2010. The numbers are identification codes used for traceability. This information is used to contact customers if a tire defect requires a recall.

ST: Indicates the tire is a special tire for trailers in highway service.

215: Indicates the nominal width of the tire in millimeters from sidewall edge to sidewall edge. In general, the larger the number, the wider the tire will be.

65: Indicates the aspect ratio which gives the tire's ratio of height to width.

R: Indicates a "radial" type tire.

15: Indicates the wheel or rim diameter in inches.

Tire Ply Composition and Materials Used: Indicates the number of plies or the number of rubber-coated fabric in the tire tread and sidewall. Tire manufacturers also must indicate the ply materials in the tire and the sidewall, which include steel nylon, polyester, and others.

Maximum Load Rating: Indicates the maximum load in kilograms and pounds that can be carried by the tire. Refer to the Certification Label on the port forward half of the trailer for the correct tire pressure for your trailer.

NOTICE: Manufacturer's Tire Registry; be sure to fill out the tire registration form provided with your owner's packet. Mail it to the tire manufacturer for the purpose of Federal defect notification regulations.

SAMPLE TIRE REGISTRATION

B-193 (1-05)
701-100-298

IMPORTANT

In case of a recall, we can reach you only if we have your name and address. You **MUST** send in this card to be on recall list.
Do it today.

SHADED AREAS MUST BE FILLED IN BY SELLER

CUSTOMER'S NAME (PLEASE PRINT)	QTY	TIRE IDENTIFICATION NUMBER															
		1	2	3	4	5	6	7	8	9	10	11	12	13			
CUSTOMER'S ADDRESS																	
CITY STATE ZIP CODE																	
NAME OF DEALER WHICH SOLD TIRE																	
DEALER'S ADDRESS																	
CITY STATE ZIP CODE																	
DEALER NON-SIG #																	

8890480061

INFLATING YOUR TIRES

Safe operation of your trailer requires that your tires are properly inflated. Remember that a tire can lose up to half of its air pressure without appearing flat. Before each trip, check your tires with a tire gauge, including the spare (if equipped). Inflate all tires to the inflation pressure recommended on the Certification Label located on the port side of the forward half of the trailer. Failure to follow the tire pressure recommendations can cause uneven treadwear patterns and adversely affect the way your trailer handles.

Certification Label and Tire label

MANUFACTURED BY / FABRIQUE PAR:	DATE:		TIRE AND LOADING INFORMATION Total load should never exceed kgs. or lbs.																
G/VWR / PNBV GAWR (EACH AXLE) / PNBG (CHAQUE ESSIEU)	KG (LB) Tires / Pneu																		
RIMS / JAANTE	LOAD CAPACITY KG(LB)	<table border="1"> <thead> <tr> <th>TIRE</th> <th>SIZE</th> <th>COLD TIRE PRESSURE</th> <th>SEE OWNER'S</th> </tr> </thead> <tbody> <tr> <td>FRONT</td> <td></td> <td></td> <td>MANUAL FOR</td> </tr> <tr> <td>REAR</td> <td></td> <td></td> <td>ADDITIONAL</td> </tr> <tr> <td>SPARE</td> <td></td> <td></td> <td>INFORMATION</td> </tr> </tbody> </table>		TIRE	SIZE	COLD TIRE PRESSURE	SEE OWNER'S	FRONT			MANUAL FOR	REAR			ADDITIONAL	SPARE			INFORMATION
TIRE	SIZE			COLD TIRE PRESSURE	SEE OWNER'S														
FRONT			MANUAL FOR																
REAR			ADDITIONAL																
SPARE			INFORMATION																
COLD INFL. PRESS. / PRESS. DE GONFL. A FROID	KPA (PSI / LPC) <input type="checkbox"/> SINGLE <input type="checkbox"/> DUAL																		
<small>THIS VEHICLE CONFORMS TO ALL APPLICABLE U.S. FEDERAL MOTOR VEHICLE SAFETY STANDARDS IN EFFECT ON THE DATE OF MANUFACTURE SHOWN ABOVE. THIS VEHICLE CONFORMS TO ALL APPLICABLE STANDARDS PRESCRIBED UNDER THE CANADIAN MOTOR VEHICLE SAFETY REGULATIONS IN EFFECT ON THE DATE OF MANUFACTURE. - CE VEHICULE EST CONFORME A TOUTES LES NORMES QUI LUI SONT APPLICABLES EN VERTU DU REGLEMENT SUR LA SECURITE DES VEHICULES AUTOMOBILES DU CANADA EN VIGUEUR A LA DATE DE SA FABRICATION.</small>																			
V.I.N. / N.I.V.:	TYPE / TYPE: TRAILER TRA / REM																		

When weather temperature changes occur, tire inflation pressures also change. A 10° F (6° C) temperature drop can cause a corresponding drop of 1 psi (7 kPa) in inflation pressure.

Under-inflation is the most common cause of tire failures and may result in severe tire cracking, tread separation or “blowout”, with unexpected loss of vehicle control and increased risk of injury. Under-inflation increases sidewall flexing and rolling resistance, resulting in heat buildup and internal damage to the tire. It also may result in unnecessary tire stress, irregular wear, loss of vehicle control and accidents. A tire can lose up to half its air pressure and not appear flat!

To check the pressure in your tire(s):

- 1: Check your tire(s) when they are “cold”. The term cold does not relate to the outside temperature. Rather, a cold tire is one that has not been driven for at least three hours. When you drive, your tires get warmer, causing the air pressure to increase. Therefore, to get an accurate tire pressure reading, you must measure the tire pressure when the tires are *cold* or compensate for the extra pressure in warm tires.
- 2: Remove the cap from the valve on one tire, then firmly press the tire gauge onto the valve and measure the pressure with the tire gauge.
- 3: Add (or remove) enough air to reach the recommended air pressure indicated on your Certification Label.
- 4: Replace the valve cap.
- 5: Repeat this procedure for each tire, including the spare.

TIRE CARE

Periodically inspect the tire treads for uneven or excessive wear and remove objects such as stones, nails, or glass that may be wedged in the tire grooves. Check for holes or cuts that may permit air leakage from the tire and make necessary repairs. Also inspect the tire sidewalls for cracking, cuts, bulges, and other signs of damage or excessive wear. If internal damage to the tire is suspected, have the tire demounted and inspected in case it needs to be repaired or replaced. For your safety, tires that are damaged or show signs of excessive wear should not be used because they are more likely to blow out or fail.

Improper or inadequate trailer maintenance can cause tires to wear abnormally. Inspect your tires, including the spare frequently, and replace them if one or more show signs of damage or excessive wear.

AGE

Tires degrade over time, even when they are not being used. It is recommended the tires generally be replaced after 6 years of normal service. Heat caused by hot climates or frequent high loading conditions can accelerate the aging process. You should replace the spare tire when you replace the other tires due to the aging of the spare tire.

LOAD CARRYING CAPACITY

The certification label shows the maximum load-carrying capacity and is located on the port forward side of the trailer.

GVWR is the Gross Vehicle Weight Rating. It is the total combined weight of the trailer and its maximum load-carrying capacity. **DO NOT** exceed the GVWR rating for the trailer.

Total Load is the maximum load-carrying capacity of the trailer minus the weight of the trailer.

Locate the statement “Total load should never exceed XXX kg or XXX lbs.” on your trailer’s tire label located on the port forward side of your trailer.

This figure equals the available amount of the boat with all equipment, gear, fuel, water, and luggage load capacity.

Determine the combined weight of the boat with all equipment, gear, fuel, water, and luggage being loaded on the trailer. That weight may not safely exceed the tire label’s total load.

Sample Tire Label

Improper weight distribution can place excessive strain on the towing vehicle and trailer. It can also cause the trailer to “fishtail” (sway side to side). Be sure gear and luggage are distributed evenly in the boat.

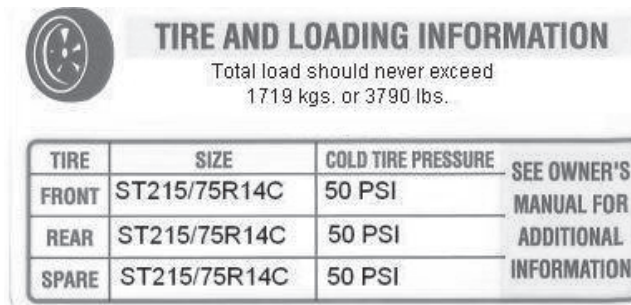

GLOSSARY OF TIRE TERMINOLOGY:

Tire label: A label showing the tire sizes, recommended inflation pressure, and the maximum weight the trailer can carry.

Tire Identification Number (TIN): A number on the sidewall of each tire providing information about the tire brand, manufacturing plant, tire size, and date of manufacture. It is also referred as the DOT code.

Inflation pressure: A measure of the amount of air in a tire.

kPa: Kilopascal, a metric unit of air pressure.

PSI: Pounds per square inch, a standard unit of air pressure.

Cold tire pressure: The tire pressure when the trailer has been stationary and out of direct sunlight for an hour or more and prior to the trailer being pulled 1 mile (1.6 km)

Recommended inflation pressure: The cold inflation pressure found on the certification label or tire label located on the port forward side of the trailer.

Bead area of the tire: Area of the tire next to the rim.

Sidewall of the tire: Area between the bead area and the tread.

Tread area of the tire: Area of the perimeter of the tire that contacts the road when mounted on the trailer.

Rim: The metal support (wheel) for a tire upon which the tire beads are seated.

RANGERTRAIL® PARTS LIST

#	DESCRIPTION
1.	Brake Actuator
2.	Swing Tongue
3.	Front Step
4.	Ranger Trail® decal
5.	Winch Stand
6.	Bow Roller (3 pcs)
7.	Winch
8.	Parking Brake
9.	Center Swing Jack
10.	Swing Jack Mounting Plates
11.	Wheel and Tire
12.	Fiberglass Fender
13.	Side Marker Light (Amber)
14.	Trailing Arm and Hub
15.	Rear Side Marker Light (Red)
16.	Stop Turn Light
17.	Backup Light
18.	Ratchet Tie Down Strap
19.	Keel Roller
20.	Center Bunk Board
21.	Outside Bunk Board
22.	Fender Board
23.	Complete Torsion Axle

RANGERTRAIL® PARTS

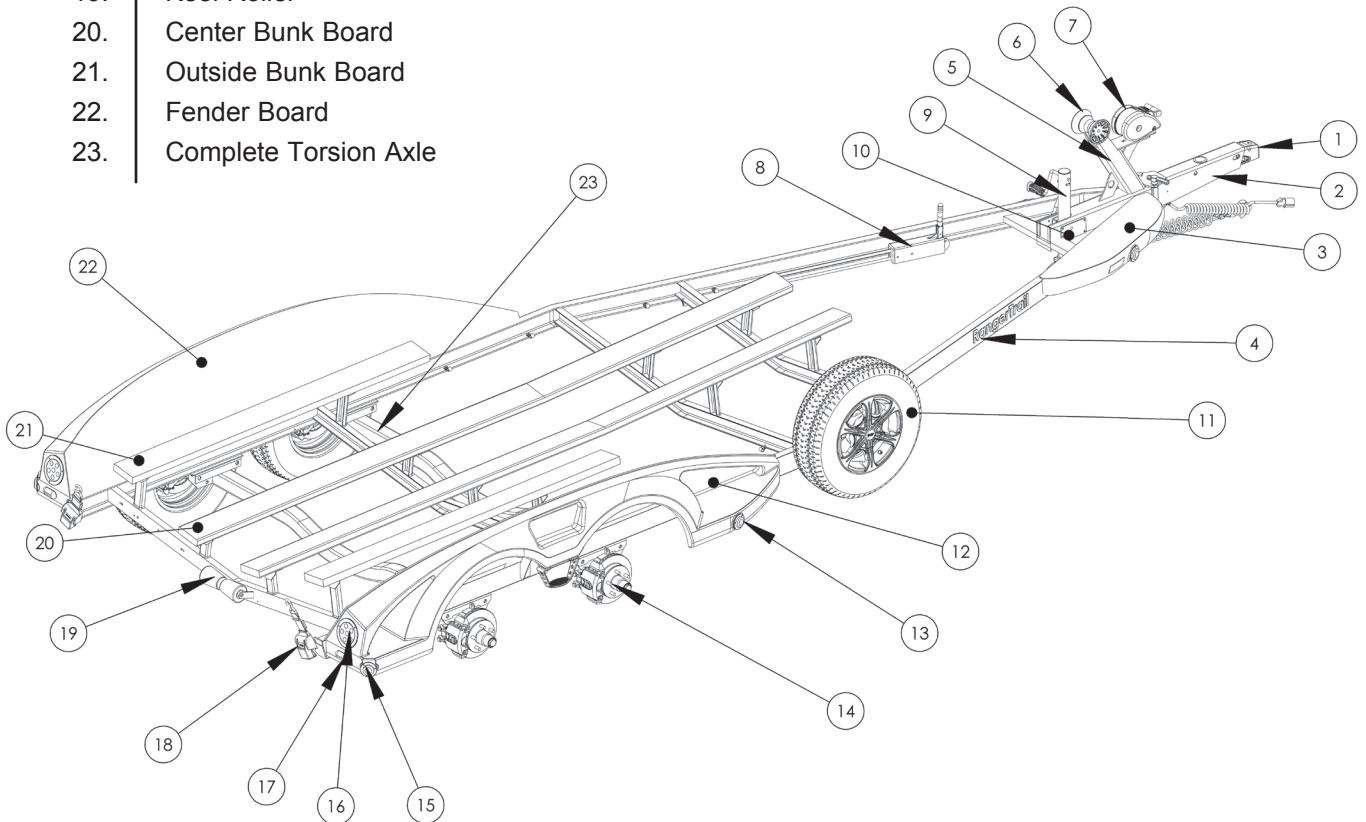



**RANGER® BOATS
LIMITED WARRANTY
RANGER FIBERGLASS BOATS AND RANGER TRAIL® TRAILERS**

NORTH AMERICAN

Fishing Holdings, LLC dba Ranger Boats (“Ranger”) warrants to you, the first North American retail purchaser of this Ranger fiberglass boat and/or trailer, or a second North American retail purchaser as noted below (“you”), that it will repair or replace, at its sole discretion, defects in materials or workmanship that occur and are reported to Ranger, or its factory authorized fiberglass dealer, within the applicable limited warranty periods, subject to the terms, conditions and exclusions set forth below. Your acceptance of delivery of the warranted Ranger fiberglass boat and/or trailer constitutes your acceptance of the terms of this limited warranty. This limited warranty gives you specific legal rights and you may have other rights which may vary from state to state.

This limited warranty is the sole and exclusive express warranty from Ranger regarding your Ranger fiberglass boat and/or trailer and there are no express warranties which extend beyond those outlined in this limited warranty. There are no implied warranties from Ranger, unless otherwise required under applicable law, and ALL IMPLIED WARRANTIES (INCLUDING ANY IMPLIED WARRANTY OF MERCHANTABILITY OR FITNESS FOR A PARTICULAR PURPOSE) ARE EXCLUDED AND DISCLAIMED WHERE ALLOWED BY APPLICABLE LAW. ANY IMPLIED WARRANTIES (IF APPLICABLE) ARE LIMITED TO THE MINIMUM PERIOD OF TIME ALLOWED UNDER APPLICABLE LAW. Some states do not allow limitations on how long an implied warranty lasts, so the above limitations may not apply to you.

Coverage Under This Limited Warranty:

Structural Hull Limited Warranty: For the first North American retail purchaser, the limited warranty period for Structural Hull Defects (defined below) runs for the duration of their period of ownership. For the second North American retail purchaser (if applicable), if properly transferred in compliance with the transfer requirements set forth in this document, the limited warranty period for Structural Hull Defects runs for ten (10) years from the date the limited warranty period began to run for the first North American purchaser. The “Hull” shall mean the single fiberglass molded shell and integral structure within that shell, including stringers, floorboards, transom and related structural reinforcements, all of which are below the Hull flange (i.e. gunwale). A “Structural Hull Defect” shall mean a substantial defect in the fiberglass boat’s Hull, which causes the fiberglass boat to be unfit or unsafe for general use as a pleasure craft under normal operating conditions.

Non-Structural Parts And Components Limited Warranty

The limited warranty period runs for three (3) years for the following non-structural parts and components:

1. Carpet fade
2. Steering helm, cylinder, hoses and cables
3. Aeration pumps, valves and timers
4. Bilge pump
5. Fiberglass boat electrical system
6. Seat pedestals
7. Fuel tanks
8. Deck hardware such as locks, cleats and fasteners
9. Factory installed battery charger(s)
10. Ranger Trail® trailer

The limited warranty period runs for one (1) year for the remaining non-structural parts and components.

Exterior Cosmetic Gel Coat Limited Warranty: The limited warranty period runs for one (1) year for cracking, crazing and fading of the fiberglass boat’s exterior cosmetic gel coat.

The applicable limited warranty period, for both the First and Second (if applicable) North American retail purchasers runs from the date of delivery of the fiberglass boat and/or trailer to the first North American retail purchaser, provided that the fiberglass boat and/or trailer is delivered to that first North American retail purchaser within twenty-four (24) months from the date of its manufacture. For a fiberglass boat and/or trailer delivered to that first North American retail purchaser more than twenty-four (24) months after the date of its manufacture, the limited warranty period runs from the date of its manufacture, not from the date the fiberglass boat and/or trailer was delivered to that first North American purchaser. All limited warranties run concurrently.

This limited warranty extends only to the first North American retail purchaser. However, it may be transferred to a second North American retail purchaser for a non-refundable recording fee of \$100 (made payable to your authorized fiberglass dealer), which must be paid within fifteen (15) days of the purchase, provided the second North American retail purchaser purchases the fiberglass boat and/or trailer from the original purchaser or an authorized Ranger fiberglass dealer, and provided the transfer occurs within five (5) years of the original retail sale to the First North American retail purchaser. Proof of the purchase date is required. This limited warranty may only be transferred **once**. Ranger reserves the right to reject a limited warranty transfer request for a Ranger fiberglass boat and/or trailer that has been damaged, neglected or otherwise previously excluded from limited warranty coverage.

THIS LIMITED WARRANTY DOES NOT COVER:

1. A fiberglass boat and/or trailer purchased from any party other than an authorized Ranger dealer or the first North American retail purchaser.

{00063859-?Vers

Warranty

2. A fiberglass boat and/or a trailer, including its components, that has been altered or modified so as to adversely affect its operation, performance or durability, as determined by Ranger, or a fiberglass boat and/or trailer that has been salvaged, declared a total loss or a constructive total loss for any reason not covered in this limited warranty.
3. Any damage resulting from an accident or impact with another object or any damage caused by an act of nature.
4. Damage, breakage and leakage around windshields, hatches or other designed openings.
5. Gel coat finishes (except as noted above), including blistering, chalking, discoloration or stars; wood finishes (varnish, stains and paints); plastics; plated or painted metal; stainless steel finishes and anti-fouling bottom paint.
6. Damage (including due to rainwater leakage), deterioration, fraying, tearing, wearing or shrinkage of carpet, upholstery (including fabric and vinyl), exterior canvas tops, enclosures, weather covers or other soft goods.
7. A fiberglass boat that has been overpowered, according to the fiberglass boat's maximum recommended engine horsepower, or overloaded in excess of the maximum limits as stated on the U.S. Coast Guard Capacity Plate.
8. A fiberglass boat with an engine setback that is in excess of eight (8) inches, with the following exceptions: four (4) inches on a 168; ten (10) inches on a Z520L, Z521L, Z521c, Z519L or Z519; six (6) inches on Z521L, Z520L, Z521c, Z520c, Z518L, Z519L and Z519 rigged with an Evinrude G2; fourteen (14) inches on 2350 and 2510; eight (8) inches on 2350 and 2510 rigged with an Evinrude G2 or Mercury Verado; four (4) inches on a 621FS, 620FS or 619FS rigged with an Evinrude G2 or Mercury Verado.
9. Estimated characteristics such as weight, speed and fuel consumption or other estimated performance characteristics.
10. Any fiberglass boat and/or trailer that has been misused or used in a negligent manner; a fiberglass boat that has been used for racing, speed or endurance contests; used for rental; used without normal maintenance; operated contrary to any instruction furnished by Ranger, improperly lifted or trailered; improperly secured to a trailer or operated in violation of any federal, state, local, Coast Guard or other governmental agency laws, rules or regulations.
11. Dealer preparation, cleaning, final adjustments and alignments in preparing the fiberglass boat and/or trailer for delivery.
12. Trailer tires, paint chipping, rust/corrosion, axle alignment and trailer components manufactured by companies other than Ranger.
13. Damage to trailers from use in salt or brackish water, except those trailers designed for salt/brackish water use.
14. Damage caused by improper trailering or mismatching of a Ranger fiberglass boat to a trailer; or failure to properly secure the fiberglass boat to a trailer.
15. Engines, powertrains, outdrives, controls, propellers, batteries, trailers and other equipment, accessories or components that are not manufactured by Ranger, whether or not they are warranted by other manufacturers. **Note:** it is the purchaser's responsibility to complete any limited warranty registration procedure that may be applicable to these components.
16. Any failure or defect arising from a previous repair made by a non-authorized service provider, unless preapproved by Ranger.
17. Structural welds in the T-top or hardtop tubular frames that have been modified or forced to bear excessive weight.
18. Any defect that results in the redesign of the Ranger fiberglass boat and/or trailer.

THE SOLE AND EXCLUSIVE REMEDY UNDER THIS LIMITED WARRANTY AND ANY APPLICABLE IMPLIED WARRANTY IS THE REPAIR OR REPLACEMENT, AT RANGER'S SOLE OPTION, OF WARRANTED PARTS AND COMPONENTS. RANGER EXCLUDES AND DISCLAIMS ANY LIABILITY FOR INCIDENTAL OR CONSEQUENTIAL DAMAGES INCLUDING LOSS OF TIME, INCONVENIENCE, INSTALLMENT PAYMENTS, INSURANCE PAYMENTS, MARINA FEES, RETAIL CHARGES, TRAVEL EXPENSES, LOSS OF USE, HAUL OUT, LAUNCH, TOWING AND/OR STORAGE CHARGES, LOSS OF OR DAMAGE TO PERSONAL PROPERTY OR OTHER SIMILAR COSTS AND EXPENSES, OR ANY CLAIM NOT SPECIFICALLY COVERED BY THIS LIMITED WARRANTY. Some states do not allow the exclusion or limitation of incidental or consequential damages, so the above limitation or exclusion may not apply to you. Any legal action alleging breach of any applicable warranty coverage must be brought within one (1) year from the date the alleged breach first occurred or the shortest period allowed under applicable law, whichever is earlier.

In order to activate limited warranty coverage on their fiberglass boat and/or a trailer, the first North American retail purchaser must warranty register the fiberglass boat and/or trailer through an authorized Ranger fiberglass dealer via Ranger's online dealer extranet, within fifteen (15) days of delivery of the fiberglass boat and/or trailer. All information received by Ranger via the limited warranty registration or transfer process shall be the property of Ranger, and submission of information, directly or indirectly, via the limited warranty registration process shall, to the extent permitted by applicable law, be deemed to constitute consent by the purchaser and fiberglass dealer to Ranger's use of such information at any time for all purposes allowed by law, including use of that information by third parties selected by Ranger. You may opt to not have your personal information disclosed to third parties and/or to not receive marketing materials from Ranger by sending a written request to: Ranger Boats Warranty Department, PO Box 179, 927 Highway 178 North, Flippin, AR 72634. To obtain limited warranty service, you must return the fiberglass boat and/or trailer, including any alleged defective part, to an authorized Ranger fiberglass dealer. Ranger must receive written notice of all limited warranty claims prior to the expiration of this limited warranty and be allowed an opportunity to resolve them. The authorized Ranger fiberglass dealer will carry out the limited warranty procedures (e.g. repairs, claims submissions to Ranger etc.) on the purchaser's behalf. All limited warranty work must be performed at an authorized Ranger fiberglass dealer, at the Ranger factory or at another repair facility approved by Ranger. You are responsible for the expenses associated with transporting the fiberglass boat and/or trailer to and from the repair facility.

DISPUTE RESOLUTION

RANGER'S GOAL IS TO RESOLVE ANY WARRANTY ISSUE AS QUICKLY AND FAIRLY AS POSSIBLE. PLEASE CONTACT OUR WARRANTY DEPARTMENT AT (870) 453-2222 IN THE EVENT YOU HAVE ANY QUESTIONS ABOUT THE TERMS, CONDITIONS AND LIMITATIONS

{00063859-?Vers

Warranty

CONTAINED IN THIS WARRANTY. THE PROCEDURE TO HAVE YOUR WARRANTY ISSUE RESOLVED IS SET FORTH ABOVE. IN THE EVENT THE RANGER DEALER CANNOT REMEDY THE DEFECT WITHIN A REASONABLE TIME, YOU AGREE TO WRITE US AT RANGER CUSTOMER SERVICE, 927 HIGHWAY 178 N, FLIPPIN, AR 72634, AND EXPLAIN THE ISSUE. IF RANGER'S RESPONSE TO YOUR WRITTEN EXPLANATION OF THE ISSUE IS NOT TO YOUR SATISFACTION, YOU AGREE THAT THE FOLLOWING BINDING ARBITRATION WILL APPLY.

BINDING ARBITRATION

a) You and Ranger agree to submit all disputes, claims, or controversies of any kind arising out of or related to this warranty and/or your purchase of a Ranger boat or trailer for resolution exclusively through binding arbitration. **You should review this provision carefully. This arbitration provision limits your and our ability to litigate claims in court. You and we each agree to waive your and our respective rights to a jury trial; ANY RIGHT TO A TRIAL BY JURY, WHETHER ON AN INDIVIDUAL OR A CLASS BASIS, IS HEREBY WAIVED. Any arbitration under this provision shall take place on an individual basis; class arbitrations and class actions are not permitted. You will not have the right to participate as a class representative, private attorney general, or member of any class of claimants for any claim subject to arbitration. A claim by, or on behalf of, other persons will not be considered in, joined with, or consolidated with the arbitration proceedings between you and us. Any dispute regarding the prohibitions in the prior sentence shall be resolved by the arbitrator in accordance with this arbitration provision.**

b) Arbitration is usually an informal proceeding in which disputes are decided by one or more neutral arbitrators who receive the evidence at a hearing and then issue a binding ruling in the form of an award. You and we understand that in an arbitration discovery is more limited than in a court, and review by courts is very limited.

c) A party who intends to seek arbitration must first send to the other, by certified mail, a written Notice of Dispute (a "Notice"). Any Notice to us should be addressed to General Counsel, Fishing Holdings LLC, 927 Highway 178 N, Flippin, AR 72634 (the "Notice Address"). Any Notice must (i) describe the nature and basis of the dispute, claim, or controversy and (ii) set forth the specific relief sought. If you and we do not reach an agreement to resolve the dispute, claim, or controversy within 30 days after the Notice is received, you or we may commence an arbitration proceeding. During the arbitration, the amount of any settlement offer made by you or we shall not be disclosed to the arbitrator until after the arbitrator determines the amount, if any, to which you or we are entitled.

d) You and we agree, upon written demand made by you or us, to submit to binding arbitration of any and all disputes, claims, and controversies between you and us, whether based on statute, regulation, constitution, common law, equity, or any other legal basis or theory, and whether pre-existing, present, or future, that arise out of or relate to this warranty and/or your purchase of a Ranger boat or trailer, including contract disputes, tort claims, fraud claims and fraud-in-the-inducement claims, misrepresentation, statutory claims and/or regulatory claims arising out of or relating to your Ranger boat or trailer or this warranty (including, to the fullest extent permitted by applicable law, relationships with third parties who are not parties to this warranty or this arbitration provision), or the scope or enforceability of this warranty, including the determination of the applicability of this agreement to arbitrate, and/or any other relationship or dispute between the parties (collectively, "Claims"). All parties retain the right to seek relief in a small claims court for Claims within the jurisdictional limits of the small claims court. The arbitration of any Claim shall be conducted by the American Arbitration Association (the "AAA") or any other arbitrator mutually agreed upon by you and us. In any event, the arbitration of any Claim shall be conducted in accordance with the Commercial Arbitration Rules and the Supplementary Procedures for Consumer Related Disputes (the "Rules"). The Rules are available online at www.adr.org or by calling 800.778.7879. In the event of any inconsistency between this arbitration provision and the Rules, such inconsistency shall be resolved in favor of this arbitration provision. This arbitration provision is made pursuant to a transaction involving interstate commerce, and the Federal Arbitration Act shall apply to the construction, interpretation, and enforceability of this warranty, notwithstanding any other choice of law provision contained in this warranty.

e) After the 30-day period in paragraph c) above has expired, either you or we may initiate arbitration by giving written notice of the intention to arbitrate to the other party and by filing notice with the AAA in accordance with the Rules in effect at the time the notice is filed. We may be given notice at the Notice Address.

f) A panel of no less than three (3) arbitrators shall decide all Claims. The arbitrators shall be active members in good standing of the bar for any state in the continental United States and shall be either actively engaged in the practice of law for at least five years or a retired judge.

g) You and we agree that the arbitrators shall: (i) limit discovery to non-privileged matters directly relevant to the Claim; (ii) grant only relief that is based upon and consistent with substantial evidence and applicable substantive law; (iii) have authority to grant relief only with respect to Claims asserted by or against you individually; and (iv) provide a written statement stating the disposition of each Claim and a concise written explanation of the basis for the award and shall make specific findings of fact and conclusions of law to support any arbitration award. Unless inconsistent with applicable law, and except as otherwise provided herein, each party shall bear the expense of its respective attorney, expert, and witness fees, regardless of which party prevails in the arbitration. We will pay to the AAA any portion of the arbitration filing fee that exceeds the cost of filing a lawsuit in the federal court where you live. If you are unable to pay the filing fee, we will pay it directly upon receiving a written request. We will pay all of the remaining administration fees and other costs, including the arbitrator's fees, for any non-frivolous Claim (measured by the standards set forth in Rule 11(b) of the Federal Rules of Civil Procedure) that does not exceed \$15,000. For all other Claims, the arbitrators will decide whether we or you will ultimately be responsible for paying any fees or other costs in connection with the arbitration under the Rules. Any arbitration proceedings shall be conducted in the federal judicial district of your residence, and you will be given the opportunity to attend the proceeding and be heard. If your Claim is for \$10,000 or less, we agree that you may choose whether the arbitration will be conducted solely on the basis of documents submitted to the arbitrators, through a telephonic hearing, or by an in-person hearing in accordance with the Rules. Judgment upon any award rendered in arbitration may be entered in any court having competent jurisdiction.

h) Demand for arbitration under this arbitration provision must be made before the date when any judicial action upon the same Claim would be barred under any applicable statute of limitations; otherwise, the Claim is also barred in arbitration. Any dispute as to whether any statute of limitations, estoppel, waiver, laches, or other doctrine bars the arbitration of any Claim shall be decided by arbitration in accordance with this arbitration provision.

i) Nothing in this arbitration provision shall limit the right of you or us, whether before, during, or after the pendency of any arbitration proceeding, to exercise any self-help remedies, such as set-off, or to obtain provisional or ancillary remedies or injunctive or other traditionally equitable relief, such as filing an interpleader action or seeking enforcement of intellectual property rights. You and we agree that the taking of these actions or any other participation in such litigation by you or us does not waive any right that either you or we have to demand arbitration at any time with respect to any subsequent or amended Claim filed against you or us after commencement of litigation between you and us.

{00063859-?Vers

Warranty

j) You may choose to opt out of these arbitration procedures within 30 days from the date you purchase your Ranger product ("Opt Out Deadline"). You may opt out of these arbitration procedures by completing the opt-out form located at www.rangerboats.com/arbitrationoptout and sending the opt-out form to the following notice address: Warranty Arbitration Director, Fishing Holdings, LLC, 927 Highway 178 N, Flippin, AR 72634. Any opt-out received after the Opt Out Deadline will not be valid and you must pursue your Claims in arbitration or small claims court.

k) If any portion of this arbitration provision is deemed invalid or unenforceable, the remaining portions of this arbitration provision will remain valid and enforceable.

CHOICE OF LAW; JURISDICTION AND VENUE

Except as set forth in binding arbitration clause above, this warranty shall be governed exclusively by, and construed exclusively in accordance with, the internal laws of the state of Delaware without reference to the choice of law or conflicts of law principles thereof, and all claims relating to or arising out of this warranty, or the breach thereof, whether sounding in contract, tort or otherwise, shall likewise be governed exclusively by the laws of the state of Delaware without reference to the choice of law or conflicts of law principles thereof. To the extent any action is permitted under binding arbitration clause above to be heard in a court of competent jurisdiction, such action shall take place in the state or federal courts sitting in Kent County, Delaware, the parties hereby waiving any claim or defense that such forum is not convenient or proper. Each party agrees that any such court shall have in personam jurisdiction over it for any such action, and each party consents to service of process in any manner authorized by Delaware law.

OTHER NOTES

RANGER reserves the right to make changes in design of its products, and changes or improvements to its products, at any time, including during a product year, without imposing any obligation upon Ranger to alter any of its products that were previously manufactured.

This document contains the entire limited warranty provided by Ranger. Any questions concerning the scope of this limited warranty should be directed to Ranger. The terms and conditions contained in this limited warranty may not be modified, altered or waived by any action, inaction or representation, whether oral or in writing, except upon the express, written authority of a senior management level employee of Ranger. Ranger does not authorize any person or persons (except a senior management level employee of Ranger), including Ranger fiberglass dealers, to change the terms of this limited warranty. (Note that your authorized Ranger fiberglass dealer is an independent business, authorized to sell and service Ranger products, but is not an agent of Ranger.) Ranger reserves the right to change or improve the design or manufacture of Ranger fiberglass boats and/or trailers without obligation to modify any fiberglass boat and/or trailer previously manufactured.

Ranger Boats
927 Highway 178 North
Flippin, AR 72634
Telephone: 870-453-2222

RULES OF THE ROAD FOR OUTBOARDING



**DEAD
AHEAD**



**DANGER ZONE.
GIVE WAY
TO BOATS IN THIS
AREA**



**2 POINTS ABAFT
STARBOARD BEAM**

- Keep clear of sailing craft and rowboats. Yield right of way to slower boats.
- Always keep to the right.
- Do not use your motor near swimmers or skin divers.
- Learn the sign language of the various buoys and warning signals. These are your nautical traffic signs, posted for your safety and convenience.

KNOW THE SPORT DIVER FLAG...

...And be sure to obey the rules in the waters you travel regarding divers and maintaining a safe distance from them.



BUOYS... YOUR WATERWAY SIGNPOSTS



There are three basic types of buoys: NUN (cone shaped), SPAR (spar shaped) and CAN (cylindrical shaped).

Buoys marked with a contrasting band of color indicate that the channel splits. If the buoy is a can with a red band, then the preferred channel is to the starboard side of the buoy. If the buoy is a nun with a green band, then the preferred channel is to the port side of the buoy.

Going upstream, the RIGHT (Starboard) side of the channel is marked with even numbered RED buoys, nuns or spars: the LEFT (Port) side of the channel is marked with odd numbered GREEN buoys, cans or spars. RED and WHITE vertically striped buoys indicate the middle of a channel. Always pass close to these buoys.



**PREFERRED
CHANNEL**

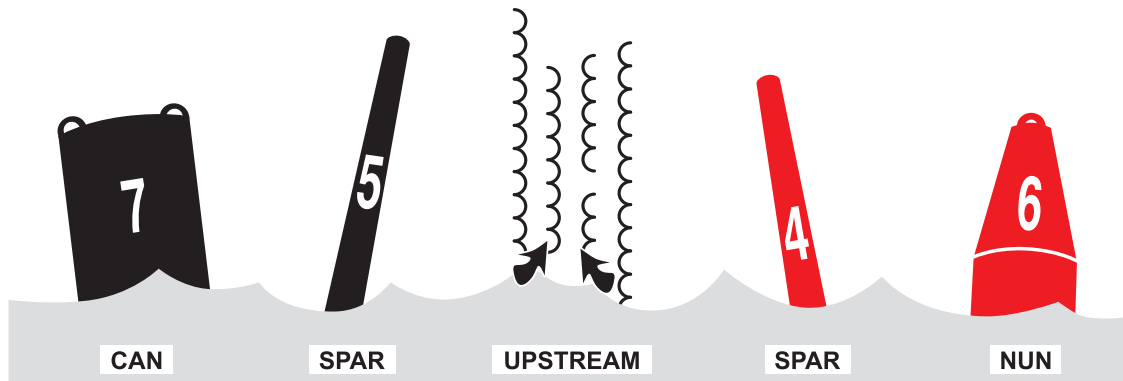



Ranger[®] BOATS

rangerboats.com

Fishing Holdings, LLC
d/b/a Ranger[®] Boats

P.O. Box 179 • Flippin, Arkansas • 72634
870-453-2222